

FURUNO

OPERATOR'S MANUAL

NETWORK FISH FINDER

Model **DFF1-UHD**

IMPORTANT NOTICES

General

- This manual has been authored with simplified grammar, to meet the needs of international users.
- The operator of this equipment must read and follow the instructions in this manual. Wrong operation or maintenance can void the warranty or cause injury.
- Do not copy any part of this manual without written permission from FURUNO.
- If this manual is lost or worn, contact your dealer about replacement.
- The contents of this manual and the equipment specifications can change without notice.
- The example screens (or illustrations) shown in this manual can be different from the screens you see on your display. The screens you see depend on your system configuration and equipment settings.
- Save this manual for future reference.
- Any modification of the equipment (including software) by persons not authorized by FURUNO will void the warranty.
- The following concern acts as our importer in Europe, as defined in DECISION No 768/2008/EC.
 - Name: FURUNO EUROPE B.V.
 - Address: Siriusstraat 86, 5015 BT, Tilburg, The Netherlands
- The following concern acts as our importer in UK, as defined in SI 2016/1025 as amended SI 2019/470.
 - Name: FURUNO (UK) LTD.
 - Address: West Building Penner Road Havant Hampshire PO9 1QY, U.K.
- All brand, product names, trademarks, registered trademarks, and service marks belong to their respective holders.

How to discard this product

Discard this product according to local regulations for the disposal of industrial waste. For disposal in the USA, see the homepage of the Electronics Industries Alliance (<http://www.eiae.org/>) for the correct method of disposal.

How to discard a used battery

Some FURUNO products have a battery(ies). To see if your product has a battery, see the chapter on Maintenance. If a battery is used, tape the + and - terminals of the battery before disposal to prevent fire, heat generation caused by short circuit.

In the European Union

The crossed-out trash can symbol indicates that all types of batteries must not be discarded in standard trash, or at a trash site. Take the used batteries to a battery collection site according to your national legislation and the Batteries Directive 2006/66/EU.

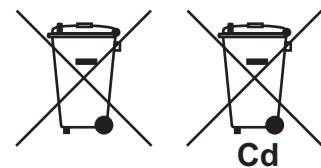

In the USA

The Mobius loop symbol (three chasing arrows) indicates that Ni-Cd and lead-acid rechargeable batteries must be recycled. Take the used batteries to a battery collection site according to local laws.

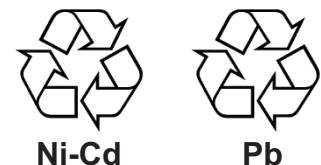



In the other countries

There are no international standards for the battery recycle symbol. The number of symbols can increase when the other countries make their own recycle symbols in the future.









SAFETY INSTRUCTIONS





The user and installer must read the appropriate safety instructions before attempting to install or operate the equipment.

| | |
|--|---|
|  WARNING | Indicates a potentially hazardous situation which, if not avoided, could result in death or serious injury. |
|  CAUTION | Indicates a potentially hazardous situation which, if not avoided, may result in minor or moderate injury. |

| | | |
|--|--|--|
|  Warning, Caution |  Prohibitive Action |  Mandatory Action |
|--|--|--|

Safety instructions for the operator

| | |
|--|---|
|  WARNING | |
|  | Do not open the equipment. Only qualified personnel can work inside the equipment. |
|  | Do not disassemble or modify the equipment. Fire, electrical shock or serious injury can result. |
|  | Turn off the power immediately if the equipment is emitting smoke or fire. Fire or electrical shock can result if the power is left on. |
|  | Turn off the power immediately if water leaks into the equipment or an object is dropped inside the equipment. Continued use can cause fire or electrical shock. |
|  | Turn off the power immediately if you feel the equipment is acting abnormally. If the equipment is hot to the touch or is emitting strange noises, turn off the power immediately and contact your dealer for advice. |







| | |
|--|---|
|  WARNING | |
|  | Do not operate the equipment with wet hands. Electrical shock can result. |
|  | Do not place liquid-filled containers on the top of the equipment. Electrical shock can result. |
|  | Use the proper fuse. Use of a wrong fuse can damage the equipment and may cause fire. |

A warning label is attached to the equipment. Do not remove the label. If the label is missing or illegible, contact a FURUNO agent or dealer about replacement.

| |
|--|
|  WARNING  |
| To avoid electrical shock, do not remove cover. No user-serviceable parts inside. |
|  警告  |
| 感電の恐れあり。 サービスマン以外の方はカバーを開けないで下さい。内部には高電圧部分が数多くあり、万一さわると危険です。 |

Name: Warning Label (1)
Type: 86-003-1011-3
Code No.: 100-236-233-10

Safety instructions for the installer

|  WARNING | |
|--|---|
|  | <p>Do not work inside the equipment unless qualified to do so.</p> <p>Electrical shock can occur.</p> |
|  | <p>Turn off the power before beginning the installation.</p> <p>Fire or electrical shock can result if the power is left on.</p> |
|  | <p>Be sure no water leaks at the mounting location for the transducer and temperature sensor.</p> <p>Water leakage can sink the vessel. Also, confirm that neither the transducer nor the sensor will loosen by vibration. The installer is solely responsible for the installation.</p> |
|  | <p>Confirm that the power supply voltage is within the rating of this equipment.</p> <p>Incorrect voltage will damage the equipment and may cause fire.</p> |
|  | <p>The network sounder meets waterproofing standard IP55. However, do not install the sounder outdoors.</p> <p>Fire or electrical shock can result if water gets inside the equipment.</p> |





|  CAUTION | | | | | |
|---|---|------------------|------------------|--------|--------|
|  | <p>The transducer cable must be handled carefully, following the guidelines below.</p> <ul style="list-style-type: none"> • Keep fuels and oils away from the cable. • Locate the cable away from chemicals. • Locate the cable away from locations where it might be damaged. | | | | |
|  | <p>Do not apply the power with the transducer exposed to air.</p> <p>The transducer may be damaged.</p> | | | | |
|  | <p>A magnetic compass may receive interference if it is placed too close to the network fish finder. Observe the compass safe distances shown below to prevent interference to a magnetic compass.</p> <table border="1" style="margin-left: auto; margin-right: auto;"> <tbody> <tr> <td style="text-align: center;">Standard compass</td> <td style="text-align: center;">Steering compass</td> </tr> <tr> <td style="text-align: center;">0.70 m</td> <td style="text-align: center;">0.40 m</td> </tr> </tbody> </table> | Standard compass | Steering compass | 0.70 m | 0.40 m |
| Standard compass | Steering compass | | | | |
| 0.70 m | 0.40 m | | | | |

TABLE OF CONTENTS

| | |
|--|-------------|
| FOREWORD | v |
| SYSTEM CONFIGURATION | vi |
| 1. INSTALLATION | 1 |
| 1.1 Equipment Lists..... | 1 |
| 1.2 Network Fish Finder | 2 |
| 1.3 Transducer | 3 |
| 1.4 Optional Speed/Temperature Sensors ST950-FJ46-1, ST950-FJ46-2..... | 3 |
| 1.4.1 Mounting considerations..... | 3 |
| 1.4.2 Mounting procedure..... | 3 |
| 2. WIRING | 4 |
| 2.1 Wiring Outline..... | 4 |
| 2.2 Transducer Cable, Cable for External KP (option)..... | 5 |
| 2.2.1 How to prepare the cables..... | 5 |
| 2.2.2 How to connect the transducer cable | 7 |
| 2.2.3 How to connect the cable for the external KP..... | 9 |
| 2.3 LAN Cable..... | 11 |
| 3. INITIAL SETTINGS | 13 |
| 3.1 DIP Switch Setting | 13 |
| 3.2 Operation Check | 14 |
| 4. MAINTENANCE | 15 |
| 4.1 Maintenance..... | 15 |
| 4.2 How to Replace the Fuse..... | 16 |
| 4.3 How to Restore Default Settings..... | 16 |
| APPX. 1 JIS CABLE GUIDE | AP-1 |
| APPX. 2 INSTALLATION OF TRANSDUCERS | AP-2 |
| APPX. 3 INSTALLATION OF TEMPERATURE SENSORS | AP-7 |
| SPECIFICATIONS | SP-1 |
| PACKING LIST | A-1 |
| OUTLINE DRAWING | D-1 |
| INTERCONNECTION DIAGRAM | S-1 |

FOREWORD

A Word to the Owner of the DFF1-UHD

Congratulations on your choice of the FURUNO DFF1-UHD Network Fish Finder. We are confident you will see why the FURUNO name has become synonymous with quality and reliability. Since 1948, FURUNO Electric Company has enjoyed an enviable reputation for quality marine electronics equipment. This dedication to excellence is furthered by our extensive global network of agents and dealers. This equipment is designed and constructed to meet the rigorous demands of the marine environment. However, no machine can perform its intended function unless operated and maintained properly. Please carefully read and follow the recommended procedures for operation and maintenance.

Thank you for considering and purchasing FURUNO.

Features

The DFF1-UHD is a dual frequency echo sounder designed for use with the NavNet 3D (MFD8/12/BB), NavNet TZtouch (TZT9/14/BB) and NavNet TZtouch2 (TZTL12F/15F, TZT2BB). The DFF1-UHD feeds data about underwater conditions via a LAN connection.

- FURUNO TruEcho CHIRP™ fish finders provide very high definition images.
- High resolution display greatly reduces the possibility of missing a target.
- Noise-suppressing display for enhanced detection performance.
- Fish size shown for depths up to 200 m and bottom discrimination.

Operational cautions

- Echoes are shown in high ultra definition, thus echoes are displayed differently from those presented on the conventional fish finder.
- The interference rejector operates differently from the interference rejector on the conventional fish finder, thus its effect on echoes is different.
- The transducer cannot be installed inside the vessel.
- Observe the following when using the ACCU-FISH™ feature:
 - Use the feature where the depth is 2 - 200 m.
 - The length of the TX pulse changes according to whether the feature is on or off. The appearance of the display changes with the sensitivity.
- Observe the following when using the bottom discrimination display (hereafter referred to as BDD):
 - Use the BDD under the following conditions:
 - Depth: 5-200 m (16.4-656.2 ft)
 - Speed: 10 knots or less"
 - The BDD uses depth measured from the vessel's draft in its analysis of bottom composition. Be sure to set the draft at the NavNet 3D/TZtouch/TZtouch2.
 - The TX interval slows when the BDD is active.
 - The BDD is inoperative if the transducer selection setting at the NavNet 3D/TZtouch/TZtouch2 is "Manual".
 - The BDD provides an estimate of bottom composition. Actual composition may be different.

Measure for reduction of interference

If you receive interference from the fish finder/echo sounder of another vessel, switch to single frequency operation and change the frequency and/or reduce the transmitting sound pressure level to remove the interference.

CE/UKCA declaration

With regards to CE/UKCA declarations, please refer to our website (www.furuno.com) for further information about RoHS conformity declarations.

Disclosure of Information about China RoHS

With regards to China RoHS information for our products, please refer to our website (www.furuno.com).

SYSTEM CONFIGURATION

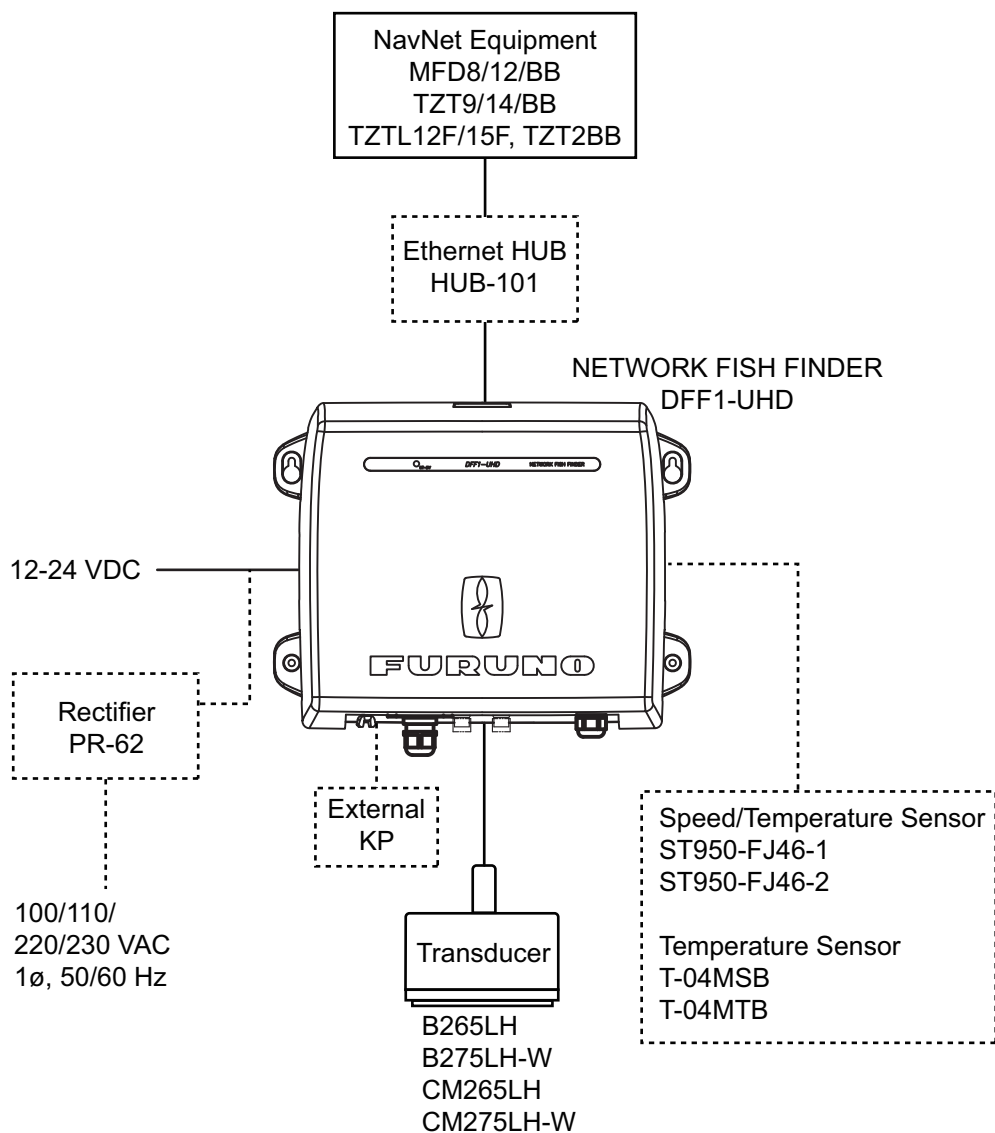

1. INSTALLATION

1.1 Equipment Lists

Standard supply

| Name | Type | Code No. | Qty | Remarks |
|------------------------|------------|-------------|-------|---|
| Network Fish Finder | DFF1-UHD | - | 1 | |
| Spare Parts | SP02-05601 | 001-033-740 | 1 set | Fuse (2 pcs.) |
| Installation Materials | CP02-08500 | 000-011-917 | 1 set | - Power cable assy. (3.5 m) - LAN cable assy. (5 m) - Self-tapping screws |

Optional supply

| Name | Type | Code No. | Remarks |
|---------------------------|---------------|----------------|--|
| Transducer | B265LH | 000-022-521 | 1 kW, bronze housing, thru hull |
| | B275LH-W* | 000-027-419 | 1 kW, bronze housing, thru hull, wide beam |
| | CM265LH | 000-022-531 | 1 kW, plastic housing, tank mount |
| | CM275LH-W* | 000-027-408 | 1 kW, plastic housing, tank mount, wide beam |
| Thru-hull pipe | TFB-7000 | 000-022-532 | |
| Tank | T-711 | 000-022-539 | |
| Cable Assembly | MOD-Z072-020+ | 001-167-880-10 | 2 m, for HUB-101 |
| Cable Assembly | MOD-Z072-100+ | 001-167-900-10 | 10 m, for HUB-101 |
| Speed/Temperature Sensor | ST950-FJ46-1 | 000-200-363-10 | Thru-hull mount, plastic |
| | ST950-FJ46-2 | 000-200-364-10 | Thru-hull mount, stainless steel |
| Temperature Sensor | T-04MSB | 000-026-893 | Thru-hull mount |
| | T-04MTB | 000-026-894 | Transom mount |
| Rectifier | PR-62 | 000-013-484 | 100 VAC |
| | | 000-013-485 | 110 VAC |
| | | 000-013-486 | 220 VAC |
| | | 000-013-487 | 230 VAC |
| Connector Kit for TX Sync | OP02-86 | 001-205-780 | |

*: Not compatible with Bottom Discrimination Display and ACCU-FISH™ features.

1.2 Network Fish Finder

The network fish finder can be installed on a desktop, deck or on a bulkhead. When selecting a mounting location, keep the following points in mind:

- This unit meets the waterproofing standard IP55. However, do not install the unit outdoors.
- The operating temperature range of this unit is -15°C to 55°C (5°F to 131°F). Be sure the mounting location satisfies this requirement.
- Locate the unit away from exhaust pipes and vents.
- The mounting location should be well ventilated.
- Mount the unit where shock and vibration are minimal.
- Keep the unit away from electromagnetic field-generating equipment such as motors and generators.
- Leave slack in cables for maintenance and servicing ease.
- A magnetic compass may receive interference from the network fish finder if it is placed too close to the network fish finder. Observe the compass safe distances noted in the safety instructions to prevent interference to the magnetic compass.
- For mounting on a bulkhead, the connectors must face downward.



Fasten the network fish finder to the mounting location with four self-tapping screws (5×20), referring to the outline drawing at the back of this manual for mounting dimensions.

1.3 Transducer

The performance of the fish finder largely depends upon the transducer position. Select a place least affected by air bubbles since turbulence blocks the sounding path. The face of the transducer must be facing the sea bottom in normal cruising trim of the boat. Further, select a place least influenced by engine noise. It is known that air bubbles are fewest at the place where the bow first falls and the next wave rises, at usual cruising speed.

Do not install the transducer inside the hull. Performance cannot be guaranteed.

1.4 Optional Speed/Temperature Sensors ST950-FJ46-1, ST950-FJ46-2

1.4.1 Mounting considerations

- Select a mid-boat flat position. The sensor does not have to be installed perfectly perpendicular. However, the sensor must not be located where it may be damaged in dry-docking operations.
- Select a place apart from equipment generating heat.
- Select a place in the forward direction viewing from the drain hole, to allow for circulation of cooling water.
- Select a place free from vibration.
- Do not install near the transducer of an echo sounder, to prevent interference to the echo sounder.

1.4.2 Mounting procedure

1. Dry dock the boat.
2. Make a hole of approx. 51 mm in diameter in the mounting location.
3. Unfasten the locknut and remove the sensor section.
4. Apply high-grade sealant to the flange of the sensor.
5. Pass the sensor casing through the hole.
6. Face the notch on the sensor toward boat's bow and tighten the flange.
7. Set the sensor section to the sensor casing and tighten the locknut.
8. Launch the boat and check for water leakage around the sensor.

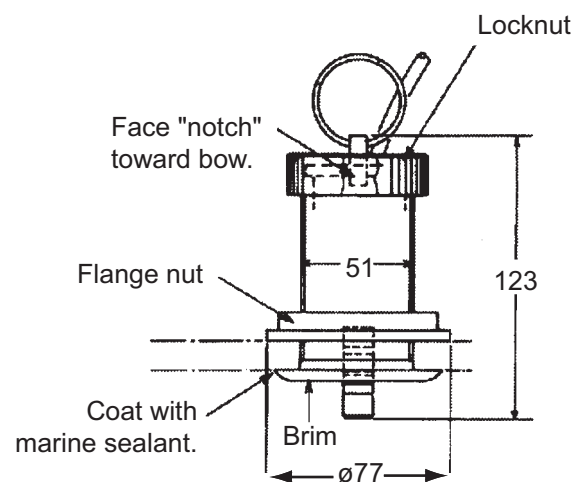

2. WIRING

2.1 Wiring Outline

Connect the power cable, transducer cables, sensor cable, network cable and ground wire to their respective locations on the network fish finder. See the next page for how to connect the transducer cable.

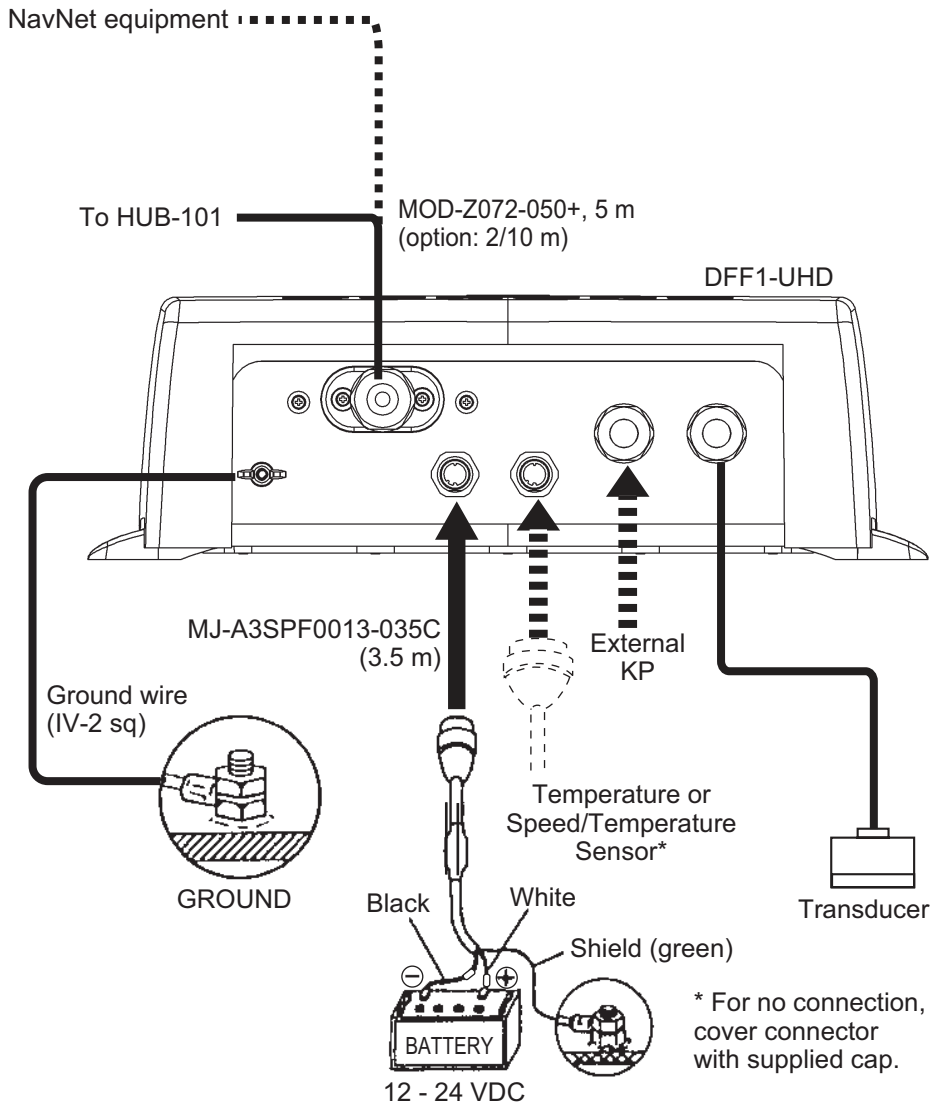

Ground

Connect a ground wire (IV-2 sq, local supply) between the ground terminal and ship's ground to prevent interference to the sounder picture. Make the length of the wire as short as possible. For FRP vessels, install a ground plate that measures approx. 20 cm by 30 cm on the outside of the hull bottom and connect the ground wire there.

| | |
|--|---|
| | CAUTION |
| | Ground the equipment to prevent mutual interference. |

2.2 Transducer Cable, Cable for External KP (option)

If the external KP is not to be connected, do only the applicable procedures in section 2.2.1 and 2.2.2.

The KP from an echo sounder or sonar can be connected to this network fish finder to synchronize transmission between the sounder and this network fish finder. Use the optional Connector Kit for TX Sync (Type, OP02-86, Code No. 001-205-780) and cable MPYC-4 (or MPYC-2) for the connection. (The MPYC-4 is a Japan Industrial Standard (JIS) cable. If not available locally, see the Appendix 1 for how to select the equivalent cable.)

Connector kit for TX sync

| Name | Type | Code No. | Qty | Remarks |
|-----------------------|--------------|----------------|-----|---------------------------|
| Upset UI Screw-B | M4×20 | 000-163-756-10 | 2 | |
| Super Gland | MGB20M-12B | 000-177-248-10 | 1 | |
| PH Connector Assembly | 02-1097 (4P) | 001-206-000 | 1 | |
| Cable Clamping Plate | 02-167-1528 | 100-379-090-10 | 1 | |
| Rainproof Panel | 02-167-1529 | 100-379-100 | 1 | No use. May be discarded. |
| EMI Core | GRFC-10 | 000-177-010-10 | 1 | |
| Crimp-on Lug | NCW-1.25 | 000-157-213-10 | 4 | |

2.2.1 How to prepare the cables

Note: The label on the transducer cable can be removed if it interferes with treatment of the cable.

How to prepare the transducer cable

CM265LH/CM275LH-W

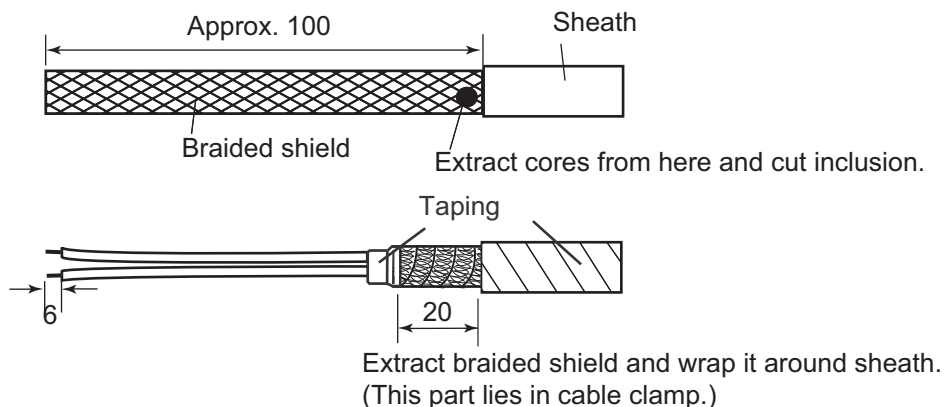

B265LH/B275LH-W

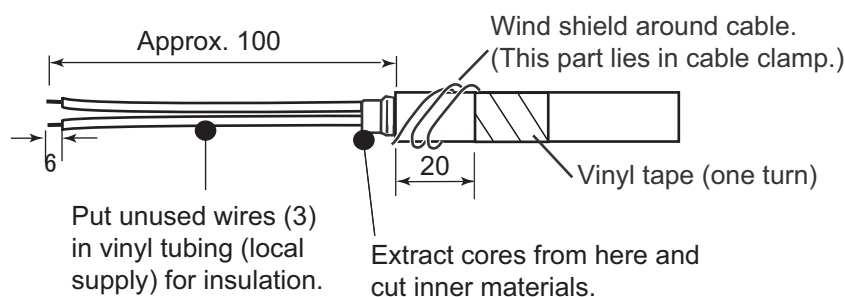

2. WIRING

How to prepare the cable for the external KP

1. Prepare the PH connector (02-1097, optional supply) as shown below.
 - a) Make the length of the wires of the PH connector 100 mm.
 - b) Remove the sheath from the cores 10 mm.
 - c) Fold back the cores in half.
 - d) Attach crimp-on lug NCW-1.25 to each core.

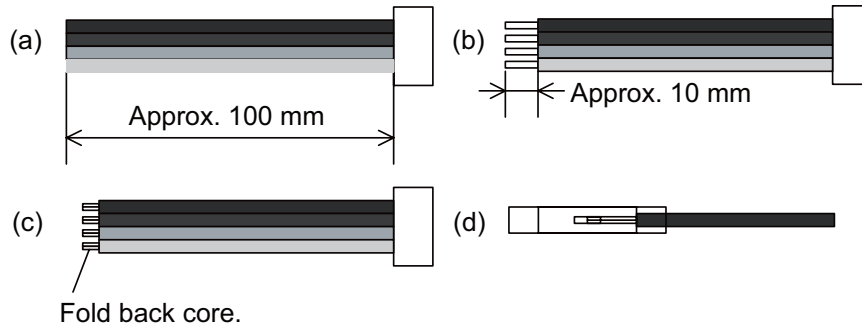

2. Remove the armor 210 mm and cut off the vinyl sheath 90 mm.

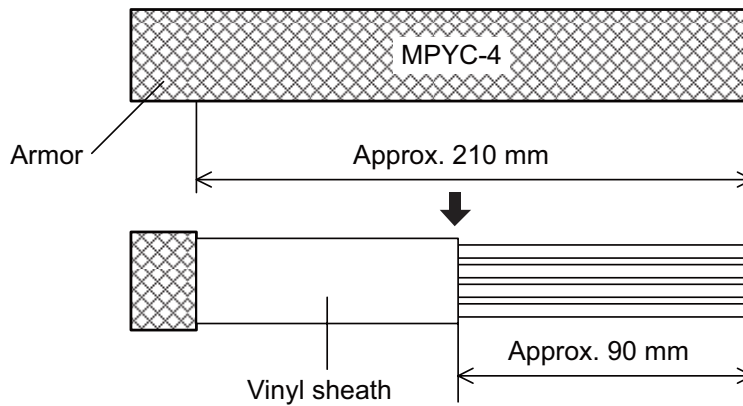

3. Remove 5 mm of the vinyl sheath from the cores then connect each crimp-on lug (attached at step 2) as shown below.

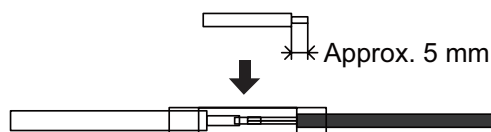

4. Wrap the armor with vinyl tape.

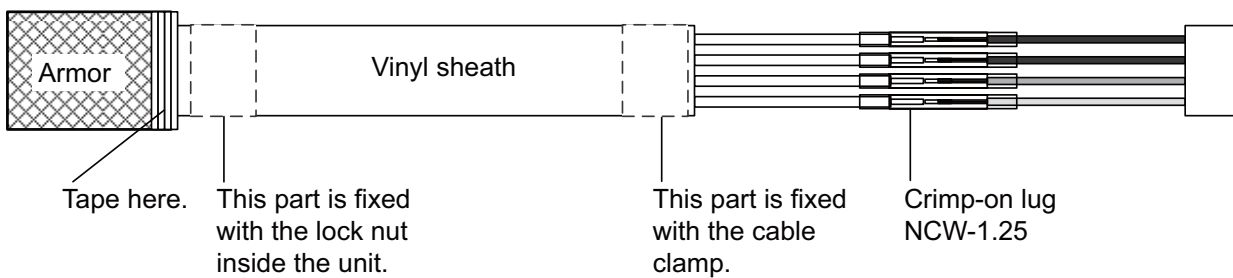

2.2.2 How to connect the transducer cable

This procedure shows you how to connect the transducer cable.

1. Open the cover - grasp the cover at two sides, spread the cover slightly and lift.
2. Loosen four screws to remove the shield cover.
3. Detach the two WAGO connectors (TB3, TB4) inside the equipment.

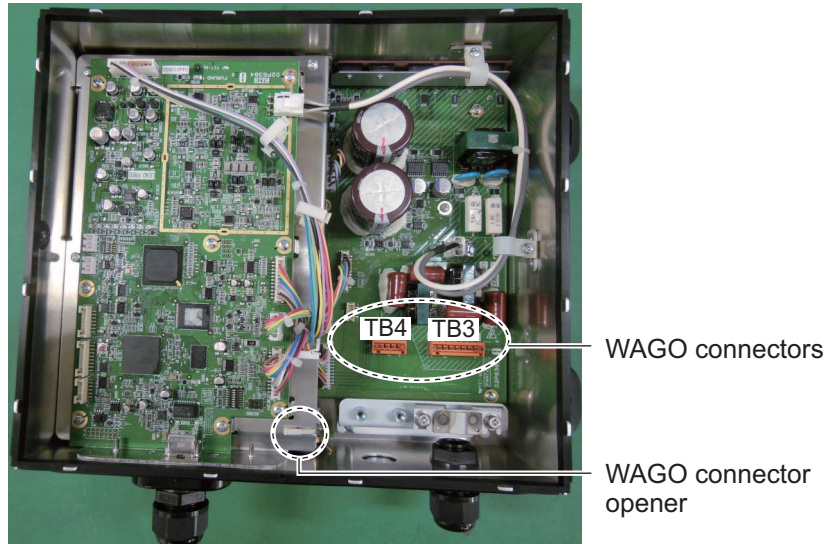

4. Unfasten the sealing nut from the super gland for the transducer cable.

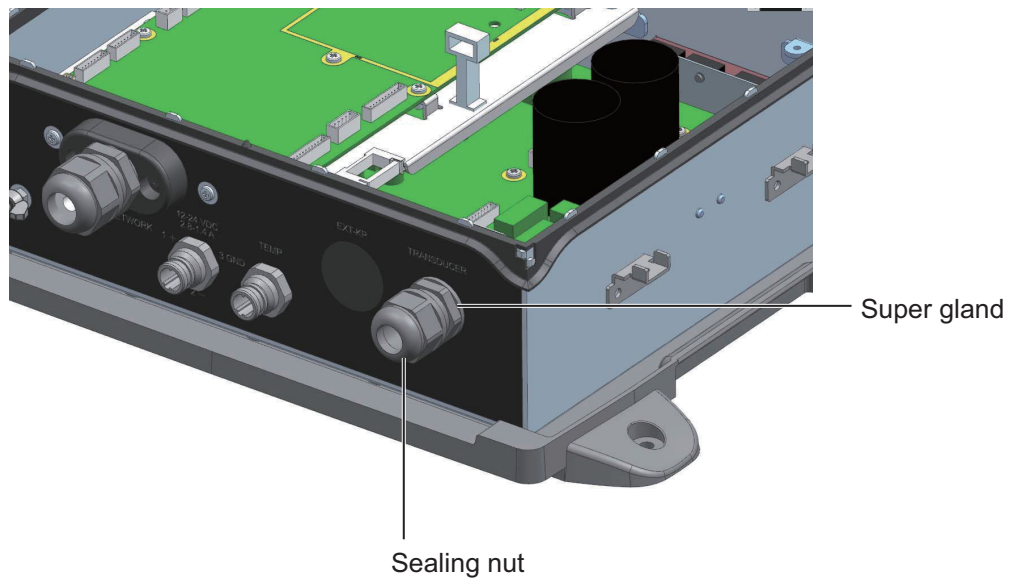

2. WIRING

5. Loosen two screws to unfasten the clamp fixing plate for the transducer cable.

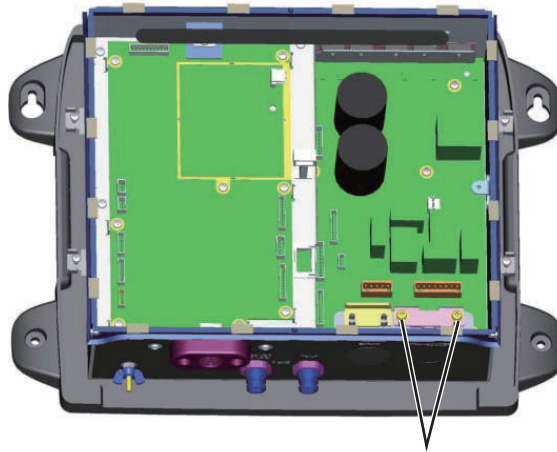

Loosen two screws to unfasten cable clamping plate for transducer cable.

6. Pass the transducer cable through the sealing nut and super gland and into the unit.
 7. Use the WAGO connector opener, attached inside the equipment (see the figure on page 7 for the location), to connect the transducer cable to the WAGO connectors, following the instructions in the figure below and the interconnection diagram.

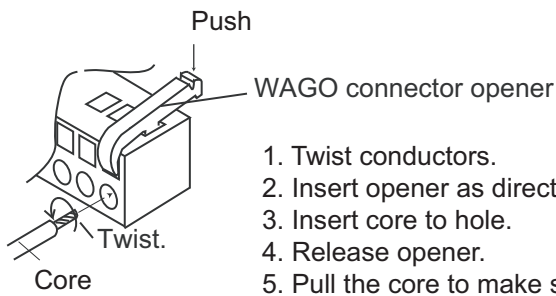

1. Twist conductors.
2. Insert opener as directed and press it down.
3. Insert core to hole.
4. Release opener.
5. Pull the core to make sure it is correctly inserted.

8. Reattach the WAGO connectors to the circuit board.
 9. Fasten the clamp fixing plate, referring to the table below for how to orient the plate.

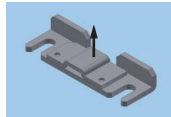
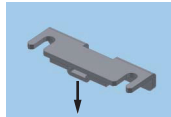
| Transducer model | Clamp fixing plate orientation | |
|-----------------------|--------------------------------|---|
| CM265LH/ CM275LH-W | Projection on plate upward |  |
| B265LH/ B275LH-W | Projection on plate downward |  |

10. Tighten the sealing nut according to the information in the table below.

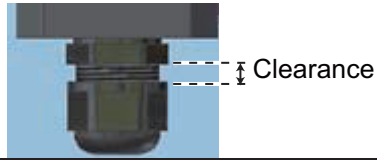
| Transducer | Clearance between super gland and sealing nut | | Torque |
|-----------------------|---|--|--------------|
| CM265LH/ CM275LH-W | 4 mm |  | 1.8 - 2.0 Nm |
| B265LH/ B275LH-W | 2 mm | | |

11. Reattach the shield cover and close the outer cover.

2.2.3 How to connect the cable for the external KP

1. Remove the cover, shield cover. (See step 1 in section 2.2.2 for how to open the cover.)
2. Detach the protective sheet from the location for the external KP.

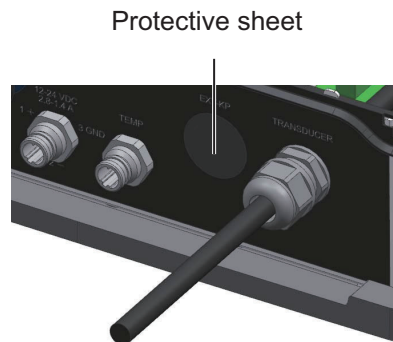

3. Do the following:

- 1) Unfasten the sealing nut and lock nut from the supplied super gland. As shown below, pass the cable through the sealing nut, super gland, hole in the network fish finder and the lock nut.
- 2) Prepare the cable end, referring to "How to prepare the cable for the external KP" on page 6.

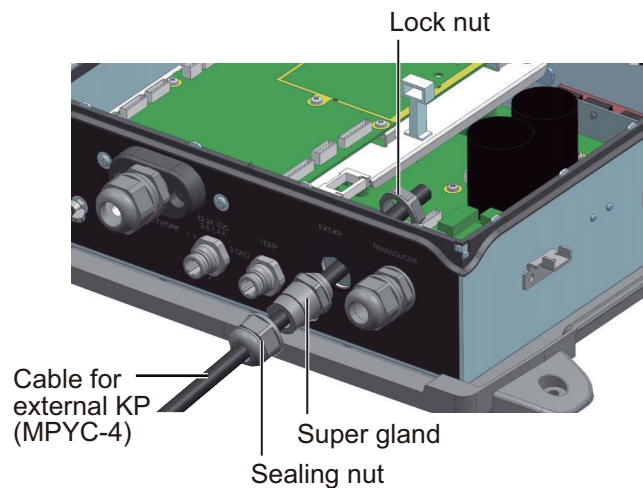

2. WIRING

4. Tighten the lock nut.
5. Tighten the sealing nut until the clearance between the nut and super gland is 4 mm. The torque for the sealing nut is 1.8 - 2.0 Nm.
6. Position the cable so the vinyl sheath lies in the cable clamp then use the supplied clamp fixing plate and two upset screws to secure the cable.

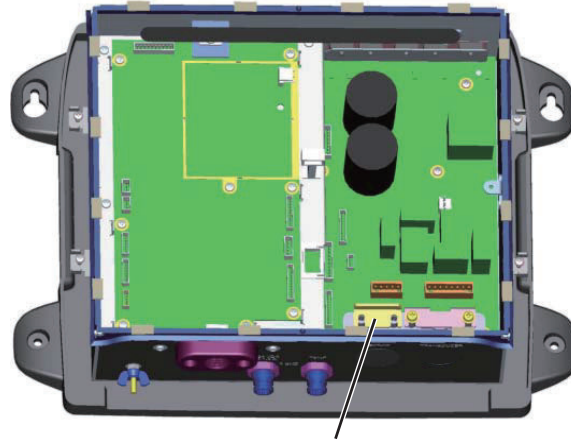
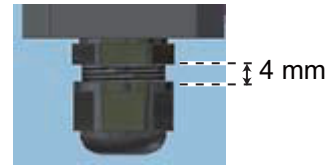

Clamp fixing plate
for external KP

7. Pass the cable through the edge saddle shown below then connect the cable to J12 on the PWRTX board. Be sure the cable does not contact TB4.

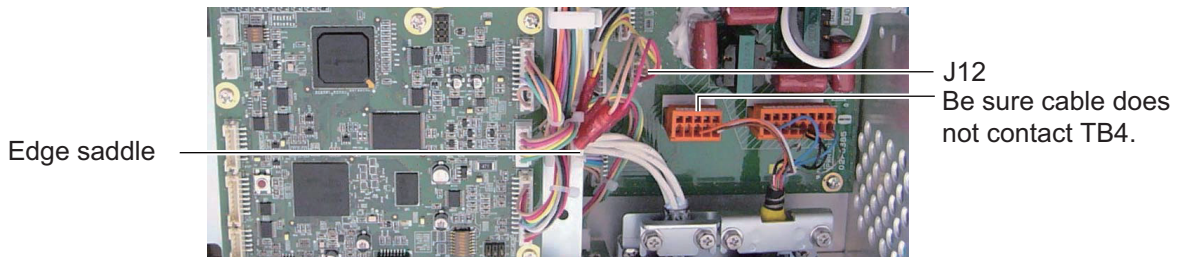

Note: For cable MPYC-2, tape the vinyl sheath of the cable (approx. 6 to 7 turns) where it lies in the cable clamp and fasten the cable clamp. The PH connector has two unused harnesses. Cut them at their base or wrap them with vinyl tape.

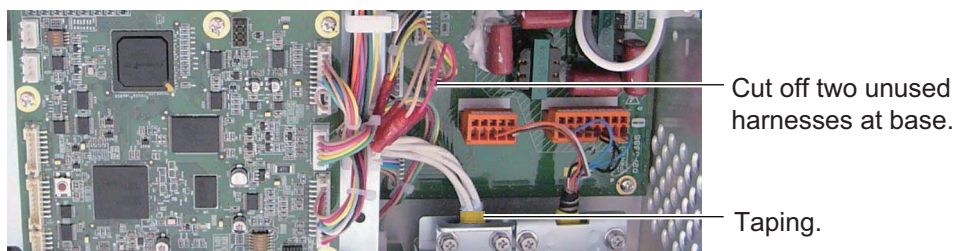

- Attach the supplied EMI core (GRFC-10) to the cable for the external KP, approx. 10 mm from the super gland.

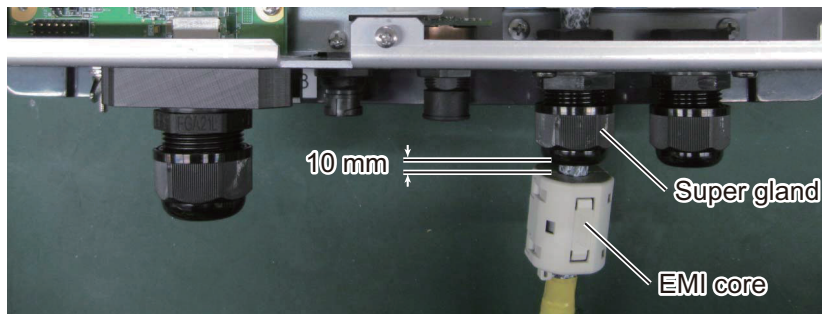

- Attach the shield cover and close the cover.

2.3 LAN Cable

Do as follows to connect the supplied LAN cable (MOD-Z072-050+) or the optional LAN cable (MOD-Z072-020+, MOD-Z072-100+).

- Unfasten the sealing nut from the LAN connector then remove the sealing insert and clamping claw.
- Detach the sealing insert from the clamping claw as shown below.

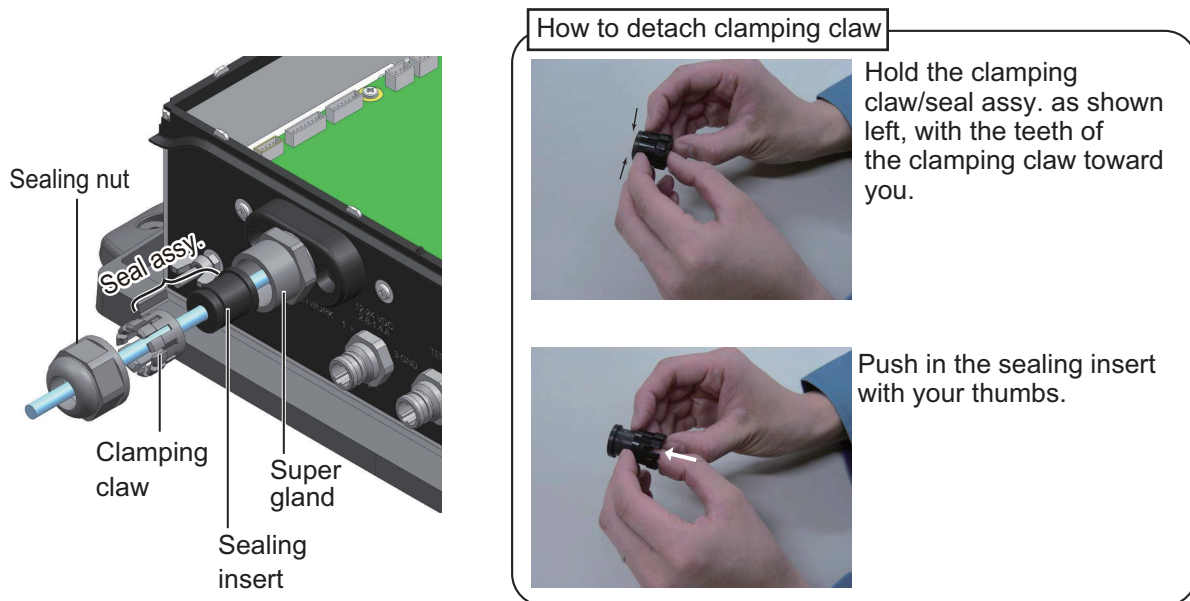

2. WIRING

3. Pass the sealing nut, clamping claw and sealing insert onto the LAN cable in the order shown in the figure below. Connect the cable to the LAN connector. (Note the orientation of the sealing insert when passing it onto the cable. Push the cable into the slit.)

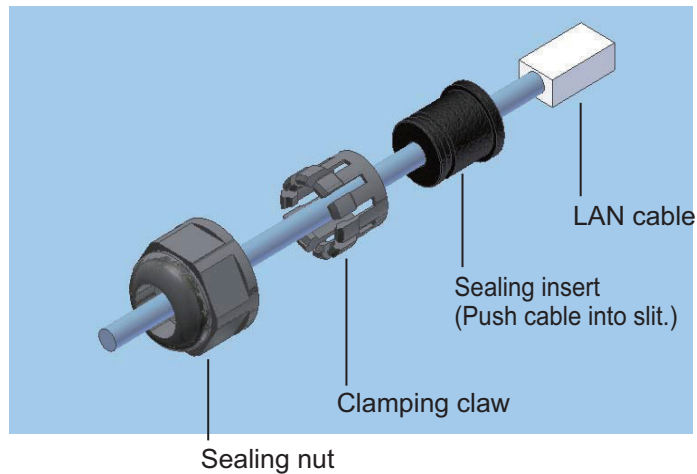

4. Set the sealing insert and clamping claw into the sealing nut then tighten the nut.
5. Tighten the sealing nut to fasten the LAN cable. The clearance between the sealing nut and the super gland shall be 3 mm. The torque for the sealing nut is 1.8 - 2.0 Nm.

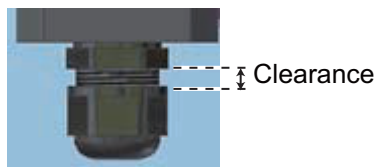

How to disconnect the LAN cable

Loosen the two screws on the gland to access the cable's connector. A lock washer is fitted to the gland, so the screws cannot be unfastened completely.

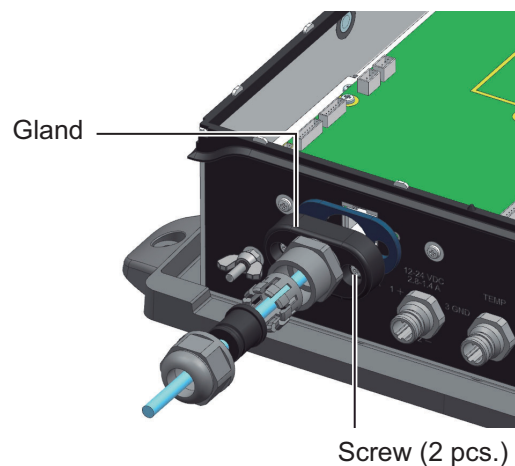

3. INITIAL SETTINGS

⚠ **WARNING**



Do not open the equipment unless totally familiar with electrical circuits.

Only qualified personnel can work inside the equipment.

3.1 DIP Switch Setting

The DIP switch S2 sets up the system according to the equipment connected. In the default setting all switches (1-8) are OFF. The DIP switch S3 should not be adjusted; leave all switches in the OFF position.

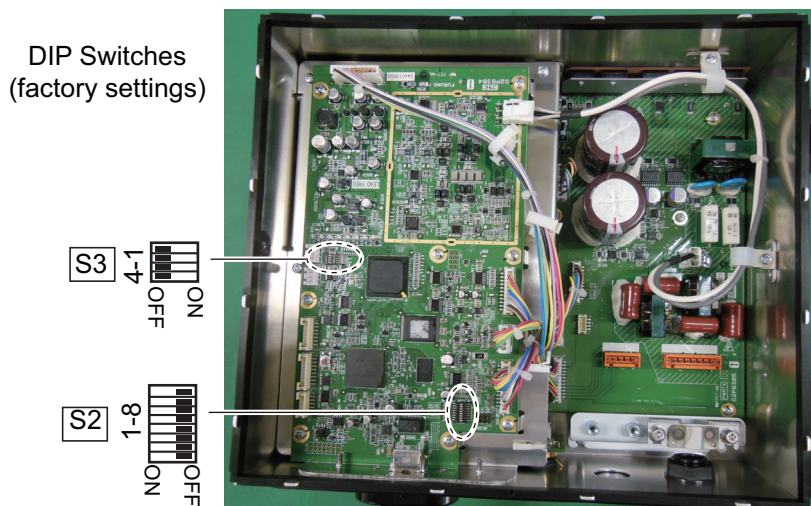

DIP switch S2 description

| Switch No. | Function | Setting |
|------------|--|--|
| 1 | IP mode | OFF: Fixed (static) IP address. Set the IP address with switch #2, referring to the table below. ON: Use IP address assigned by DHCP. |
| 2 | IP address no. | OFF: Set the #1 switch to OFF to set IP address. See the table on the next page for IP address assignment. |
| 3 | Restore default settings (other than LAN and transducer) | See section 4.3. |
| 4 | Restore ALL default settings | See section 4.3. |
| 5 - 6 | Keep these switches in the OFF position. | |
| 7 | TD-ID output ON/OFF | OFF: Output TD-ID. ON: Don't output TD-ID. Turn ON for NavNet 3D. |
| 8 | TD-ID format ON/OFF | OFF: TD-ID Format Code 2. ON: TD-ID Format Code 1. |

3. INITIAL SETTINGS

| #2 | Host name | IP address |
|-----|-----------|-----------------|
| OFF | ES092002 | 172.031.092.002 |
| ON | ES092003 | 172.031.092.003 |

After setting up the transducer at the DFF1-UHD, set the transducer type at the NavNet device. See respective Installation Manual for the procedure.

Note: DIP Switch S3 is for factory use. Do not change the settings.

3.2 Operation Check

For NavNet equipment, the DFF1-UHD is powered on/off from the ship's switchboard. The LED on the cover of the DFF1-UHD lights or blinks according to equipment state, as described in the table below.

LED state and meaning

| LED state | Meaning |
|----------------------------|---|
| Lit continuously | <ul style="list-style-type: none"> Standby state. (If no signal is received via LAN for more than 10 minutes, the equipment automatically goes into standby to lessen power consumption.) Power on (20 seconds during initialization) IP address not set |
| Blinking every two seconds | Normal operation |
| Blinking every 0.4 seconds | Transducer settings at NavNet device not properly set. |

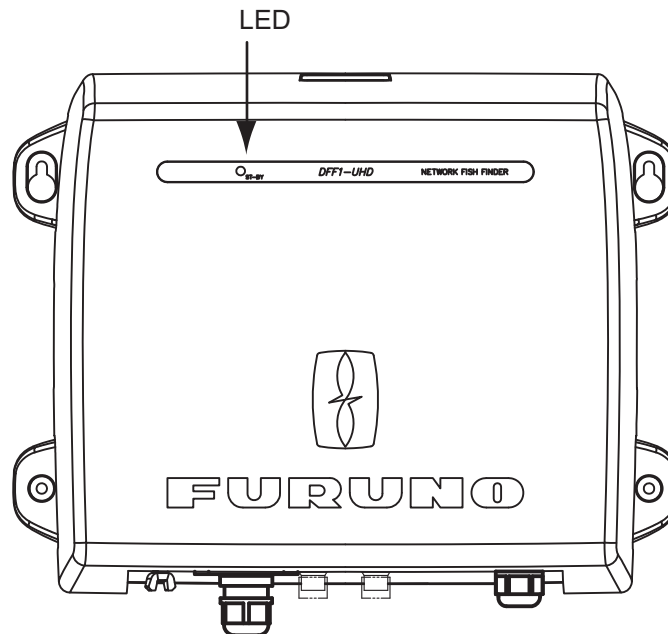

4. MAINTENANCE

 **WARNING**

 **ELECTRICAL SHOCK HAZARD**
Do not open the equipment.

Only qualified personnel can work inside the equipment.

NOTICE

Do not apply paint, anti-corrosive sealant or contact spray to coating or plastic parts of the equipment.

Those items contain organic solvents that can damage coating and plastic parts, especially plastic connectors.

4.1 Maintenance

Regular maintenance is essential for good performance. Check the items listed in the table below at the suggested interval to help keep your equipment in good shape for years to come.

| Item | Check point, action | Check interval |
|--|---|---------------------------------------|
| Transducer cable | Check that cable is tightly fastened and is not damaged. Refasten if necessary. Replace if damaged. | Once a month |
| Power cable, sensor cable | Check that these cables are tightly fastened and not damaged. Refasten if necessary. Replace if damaged. | Once a month |
| Ground terminal, ground wire | Check for corrosion. Clean if necessary. Replace wire if damaged. | Once a month |
| Power supply voltage | Check voltage. If out of rating correct problem. | Once a month |
| Cleaning the network fish finder's cabinet | Dust or dirt on the cabinet may be removed with a dry cloth. Do not use chemical-based cleaners to clean the cabinet; they can remove markings and damage the cabinet. | Once a month |
| Transducer | Marine life on the transducer face will result in a gradual decrease in sensitivity. Check the transducer face for cleanliness each time the boat is removed from the water. Carefully remove any marine life with a piece of wood or fine-grade sandpaper. | When vessel is removed from the water |

4.2 How to Replace the Fuse

The 5A fuse (Type: FGBO-A 125V 5A PBF, Code No. 000-155-853-10) in the snap-in fuse holder on the power cable protects the equipment from equipment fault and reverse polarity of the power supply. If the equipment cannot be powered, the fuse may have blown. Find out the cause for the blown fuse before replacing it. If the fuse blows again after replacement, contact a FURUNO agent or dealer for instructions.

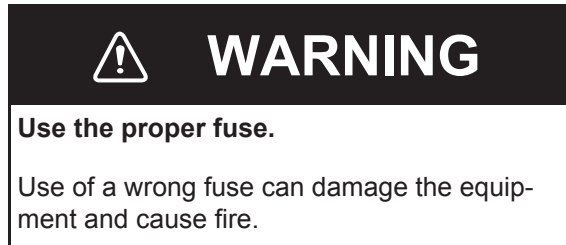

4.3 How to Restore Default Settings

This procedure restores all default sounder settings on the NavNet series device. You can restore all default settings or restore those other than transducer and LAN. This procedure should only be performed by a suitably qualified FURUNO technician.

1. Disconnect the power and LAN cables from the DFF1-UHD.
2. Open the outer cover and shield cover. Turn on the #3 or #4 switch of DIP Switch S2 as applicable.
#3: Restore default settings other than LAN and transducer.
#4: Restore all default settings. Use this when changing transducers.
3. Connect the power cable to the DFF1-UHD, and turn on the power at the ship's switchboard.
4. The LED blinks (every 0.4 seconds) when default settings are completely restored.
5. Close the shield cover and outer cover.
6. Set up the transducer at the NavNet equipment.

APPX. 1 JIS CABLE GUIDE

Cables listed in the manual are usually shown as Japanese Industrial Standard (JIS). Use the following guide to locate an equivalent cable locally.

JIS cable names may have up to 6 alphabetical characters, followed by a dash and a numerical value (example: DPYC-2.5).

For core types D and T, the numerical designation indicates the *cross-sectional Area (mm²)* of the core wire(s) in the cable.

For core types M and TT, the numerical designation indicates the *number of core wires* in the cable.

1. Core Type

D: Double core power line

T: Triple core power line

M: Multi core

TT: Twisted pair communications
(1Q=quad cable)

2. Insulation Type

P: Ethylene Propylene Rubber

3. Sheath Type

Y: PVC (Vinyl)

4. Armor Type

C: Steel

5. Sheath Type

Y: Anticorrosive vinyl sheath

6. Shielding Type

SLA: All cores in one shield, plastic tape w/aluminum tape

-SLA: Individually shielded cores, plastic tape w/aluminum tape



DPYC



TPYC



MPYC-4

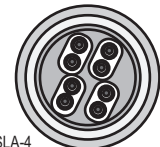

TTYCSLA-4

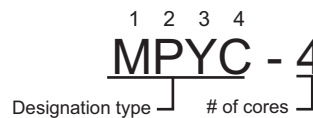
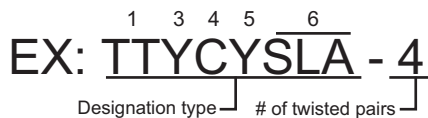

The following reference table lists gives the measurements of JIS cables commonly used with Furuno products:

| Type | Area | Core Diameter | Cable Diameter | Type | Area | Core Diameter | Cable Diameter |
|-----------|---------------------|---------------|----------------|-------------|---------------------|---------------|----------------|
| DPYC-1.5 | 1.5mm ² | 1.56mm | 11.7mm | TTYCSLA-1 | 0.75mm ² | 1.11mm | 9.4mm |
| DPYC-2.5 | 2.5mm ² | 2.01mm | 12.8mm | TTYCSLA-1T | 0.75mm ² | 1.11mm | 10.1mm |
| DPYC-4 | 4.0mm ² | 2.55mm | 13.9mm | TTYCSLA-1Q | 0.75mm ² | 1.11mm | 10.8mm |
| DPYC-6 | 6.0mm ² | 3.12mm | 15.2mm | TTYCSLA-4 | 0.75mm ² | 1.11mm | 15.7mm |
| DPYC-10 | 10.0mm ² | 4.05mm | 17.1mm | TTYCY-1 | 0.75mm ² | 1.11mm | 11.0mm |
| DPYCY-1.5 | 1.5mm ² | 1.56mm | 13.7mm | TTYCY-1T | 0.75mm ² | 1.11mm | 11.7mm |
| DPYCY-2.5 | 2.5mm ² | 2.01mm | 14.8mm | TTYCY-1Q | 0.75mm ² | 1.11mm | 12.6mm |
| DPYCY-4 | 4.0mm ² | 2.55mm | 15.9mm | TTYCY-4 | 0.75mm ² | 1.11mm | 17.7mm |
| MPYC-2 | 1.0mm ² | 1.29mm | 10.0mm | TTYCY-4SLA | 0.75mm ² | 1.11mm | 19.5mm |
| MPYC-4 | 1.0mm ² | 1.29mm | 11.2mm | TTYCYSLA-1 | 0.75mm ² | 1.11mm | 11.2mm |
| MPYC-7 | 1.0mm ² | 1.29mm | 13.2mm | TTYCYSLA-4 | 0.75mm ² | 1.11mm | 17.9mm |
| MPYC-12 | 1.0mm ² | 1.29mm | 16.8mm | TTPYCSLA-1 | 0.75mm ² | 1.11mm | 9.2mm |
| TPYC-1.5 | 1.5mm ² | 1.56mm | 12.5mm | TTPYCSLA-1T | 0.75mm ² | 1.11mm | 9.8mm |
| TPYC-2.5 | 2.5mm ² | 2.01mm | 13.5mm | TTPYCSLA-1Q | 0.75mm ² | 1.11mm | 10.5mm |
| TPYC-4 | 4.0mm ² | 2.55mm | 14.7mm | TTPYCSLA-4 | 0.75mm ² | 1.11mm | 15.3mm |
| TPYCY-1.5 | 1.5mm ² | 1.56mm | 14.5mm | | | | |
| TPYCY-2.5 | 2.5mm ² | 2.01mm | 15.5mm | | | | |
| TPYCY-4 | 4.0mm ² | 2.55mm | 16.9mm | | | | |

APPX. 2 INSTALLATION OF TRANSDUCERS

This appendix provides a copy of the installation instructions and Installation supplement for the AIRMAR transducers.

OWNER'S GUIDE & INSTALLATION INSTRUCTIONS

Thru-Hull *with Stem* Depth Transducer

with Temperature Sensor

Models: B45, B258, B260, B265LH, B265LM, B271W,
B275LH-W, SS258, SS260, SS270W, SS505

U.S. Patent No. 7,369,45; 8,582,393. UK Patent No. 2 414 077

01/10/14

17-008-05 rev. 16

Follow the precautions below for optimal product performance and to reduce the risk of property damage, personal injury, and/or death.

WARNING: A High-Performance Fairing must be installed following the installation instructions that accompany the fairing. A High-Performance Fairing requires an anti-rotation bolt to keep the fairing from turning while the boat is underway.

WARNING: Always wear safety goggles and a dust mask when installing.

WARNING: Immediately check for leaks when the boat is placed in the water. Do not leave the boat unchecked for more than three hours. Even a small leak may allow considerable water to accumulate.

CAUTION: CHIRP transducer—Always operate the transducer in water. Operating in air will allow the transducer to overheat resulting in failure.

CAUTION: Bronze transducer—Never mount in a metal hull, because electrolytic corrosion will occur.

CAUTION: Stainless steel housing in a metal hull requires using a Fairing Kit to isolate the stainless steel transducer from the metal hull. Failure to do so will cause electrolytic corrosion.

CAUTION: Never install a metal transducer on a vessel with a positive ground system.

CAUTION: Never pull, carry, or hold the transducer by the cable as this may sever internal connections.

CAUTION: Never strike the transducer.

CAUTION: Never use solvents. Cleaner, fuel, sealant, paint, and other products may contain solvents that can damage plastic parts, especially the transducer's face.

IMPORTANT: Read the instructions completely before proceeding with the installation. These instructions supersede any other instructions in your instrument manual if they differ.

Applications

- **Bronze** transducer recommended for fiberglass or wood hull only.
- **Stainless steel** transducer compatible with all hull materials. Recommended for aluminum hulls to prevent electrolytic corrosion provided the stainless steel transducer is isolated from the metal hull.

Record the information found on the cable tag for future reference.

Part No. _____ Date _____ Frequency _____ kHz

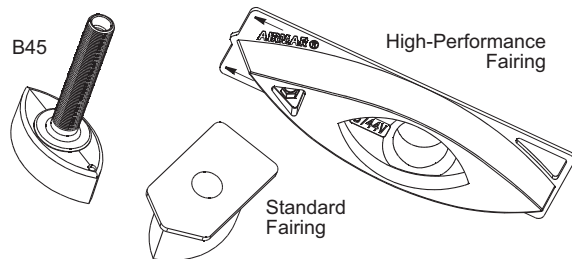

Identify Your Model

The model name is printed on the cable tag.

Tools & Materials

Safety goggles

Dust mask

Electric drill

Drill bits and hole saws:

| | |
|---|-----------------|
| Pilot hole | 3mm or 1/8" |
| B45, SS505 | 22mm or 7/8" |
| B258, B271W, SS258 | 30mm or 1-3/16" |
| B260, B265LH/LM, B275LH-W, SS260, SS270W | 33mm or 1-5/16" |

Sandpaper

Mild household detergent or weak solvent (such as alcohol)

File (installation in a metal hull)

Angle finder (installation with a fairing)

Band saw (installation with a fairing)

Rasp or power tool (installation with a fairing)

Marine sealant (suitable for below waterline)

Slip-joint pliers

Grommet(s) (some installations)

Cable ties

Water-based anti-fouling paint (**mandatory in salt water**)

Installation in a cored fiberglass hull: (see page 4)

Drill bits and hole saws for hull interior:

| | |
|---|-----------------------|
| B45, SS505 | 35mm or 1-3/8" |
| B258, B271W, SS258 | 40mm, 41mm, or 1-5/8" |
| B260, B265LH/LM, B275LH-W, SS260, SS270W | 42mm or 1-5/8" |

Cylinder, wax, tape, and casting epoxy

About Fairings

Most vessels have some deadrise angle at the mounting location. If the transducer is mounted directly to the hull, the sound beam will be tilted to the side at the same angle as the deadrise. A fairing is strongly recommended if the deadrise angle exceeds 10°. Made of a high-impact polymer with an integrated cutting guide, an Airmar fairing is safer and easier to cut with a band saw and shape with hand tools than custom fairings.

- Orients the sound beam straight down by mounting the transducer parallel to the water surface.
- Mounts the transducer deeper in the water for clean flow under the transducer's face.
- **Airmar High-Performance Fairing** has a long streamlined shape, directing water around the transducer to minimize drag. Performance is excellent above 15kn (18MPH). (To order see "Replacement Parts" on page 4.)

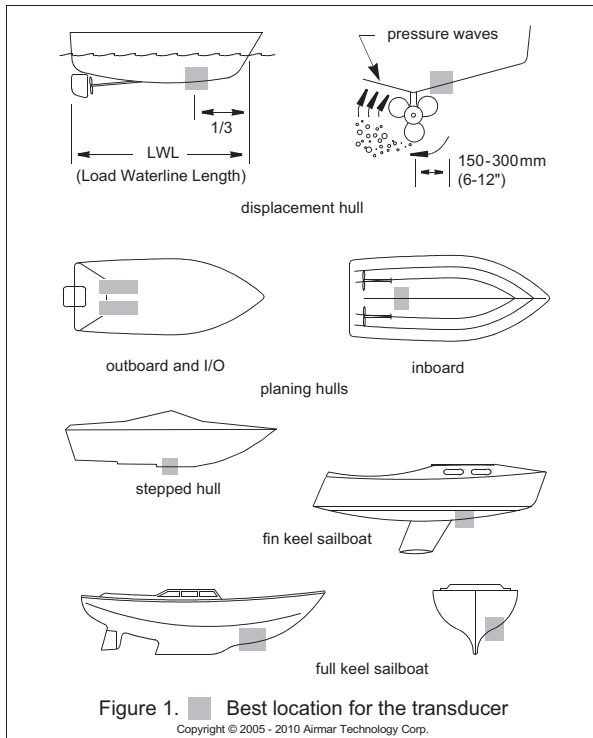

Figure 1. ■ Best location for the transducer

Copyright © 2005 - 2010 Airmar Technology Corp.

Mounting Location

Boat Types (see Figure 1)

- **Displacement hull powerboat**—Locate 1/3 of the way along the LWL and 150–300mm (6–12") off the centerline. The starboard side of the hull where the propeller blades are moving downward is preferred.
- **Planing hull powerboat**—Mount well aft near the centerline and well inboard of the first set of lifting strakes to ensure that it is in contact with the water at high speeds. The starboard side of the hull where the propeller blades are moving downward is preferred.
 - Outboard and I/O**—Mount just forward and to the side of the engine(s).
 - Inboard**—Mount well ahead of the propeller(s) and shaft(s).
 - Stepped hull**—Mount just ahead of the first step.
 - Boat capable of speeds above 25kn (29MPH)**—Review transducer location and operating results of similar boats before proceeding.
- **Fin keel sailboat**—Mount to the side of the centerline and forward of the fin keel 300–600mm (1–2').
- **Full keel sailboat**—Locate amidships and away from the keel at the point of minimum deadrise angle.

Guidelines

CAUTION: Do not mount in line with or near water intake or discharge openings or behind strakes, struts, fittings, or hull irregularities that will disturb the water flow.

CAUTION: Do not mount the sensor where the boat may be supported during trailering, launching, hauling, or storage to avoid damaging the transducer's face.

- The water flowing under the hull must be smooth with a minimum of bubbles and turbulence (especially at high speeds).
- The transducer must be continuously immersed in water.
- The transducer beam must be unobstructed by the keel or propeller shaft(s).

- Choose a location away from interference caused by power and radiation sources such as: the propeller(s) and shaft(s), machinery, other echosounders, and other cables. The lower the noise level, the higher the echosounder gain setting that can be used.
- Choose a location with a minimal deadrise angle.
- Choose an accessible spot inside the vessel with adequate space for the height of the stem and tightening the nut.
- **CHIRP transducer**—Mount in a cool well-ventilated area away from the engine to avoid overheating.

Installation: No Fairing or Standard Fairing Only

IMPORTANT: If installing the transducer with NO fairing, disregard all references to a fairing and backing block.

Hole Drilling

Cored fiberglass hull—Follow separate instructions on page 4.

1. Drill a 3mm or 1/8" pilot hole perpendicular to the waterline from inside the hull (see Figure 2). If there is a rib, strut, or other hull irregularity near the selected mounting location, drill from the outside.
2. Using the appropriate size drill bit, cut a hole from outside the hull. Be sure to hold the drill plumb, so the hole will be perpendicular to the water surface.
3. Sand and clean the area around the hole, inside and outside, to ensure the marine sealant will adhere properly to the hull. If there is any petroleum residue inside the hull, remove it with either a mild household detergent or a weak solvent (alcohol) before sanding.

Metal hull—Remove all burrs with a file and sandpaper.

Cutting the Standard Fairing

WARNING: High-Performance Fairing—For your safety it is mandatory to follow the Installation Instructions that come with the fairing.

CAUTION: The arrow/pointed end of the fairing points forward toward the bow. Be sure to orient the fairing on the band saw, so the angle cut matches the intended side of the hull and not the mirror image.

1. Measure the deadrise angle of the hull at the selected location (see Figure 2).

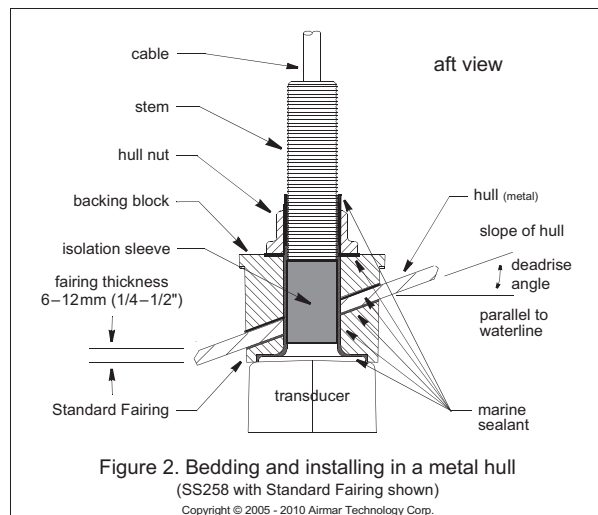
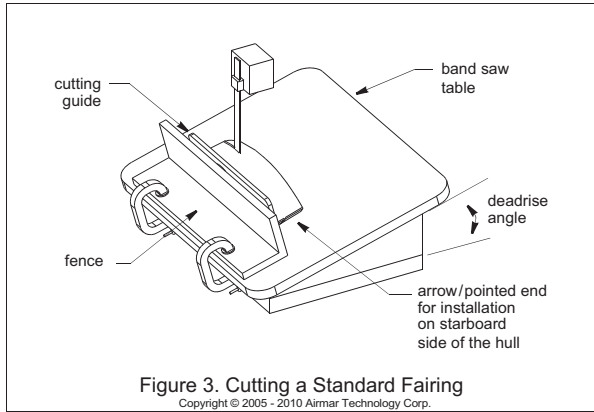

Figure 2. Bedding and installing in a metal hull (SS258 with Standard Fairing shown)

Copyright © 2005 - 2010 Airmar Technology Corp.

APPX. 2 INSTALLATION OF TRANSDUCERS



2. Tilt the band saw table to the measured angle and secure the cutting fence (see Figure 3).
3. Place the fairing on the table, so the cutting guide rests against the fence. The arrow/pointed end will be pointing *toward* you for installation on the starboard side of the boat or *away* from you for installation on the port side (see Figure 4).
4. Adjust the cutting fence, so the fairing will be cut in about two equal parts (see Figure 3). *The section that will become the fairing must be between 6–12mm (1/4–1/2") at its thinnest dimension (see Figure 2).*
5. Recheck steps 1 through 4. Then cut the fairing.
6. Shape the fairing to the hull as precisely as possible with a rasp or power tool.
7. Use the remaining section of the fairing with the cutting guide for the backing block.

Bedding

CAUTION: Be sure all surfaces to be bedded are clean and dry.

1. Remove the hull nut (see Figure 5).
 2. Thread the transducer cable through the fairing (if used).
 3. Apply a 2mm (1/16") thick layer of marine sealant to the surface of the transducer that will contact the hull/fairing and up the stem. The sealant must extend 6mm (1/4") higher than the combined thickness of the hull, fairing and backing block (if used), and the hull nut. This will ensure there is marine sealant in the threads to seal the hull and hold the hull nut securely in place.
- Stainless steel transducer/stem in a metal hull**—Slide the isolation sleeve over the bedded transducer stem as far down as possible (see Figure 2). Apply a 2mm (1/16") thick layer of the marine sealant to the outside of the sleeve.
4. Apply a 2mm (1/16") thick layer of marine sealant to the following surfaces (see Figure 5):
 - Fairing that will contact the hull
 - Backing block that will contact the hull interior
 - Hull nut that will contact the hull/backing block
 5. **Standard Fairing**—Seat the transducer firmly in/against the fairing with a pushing twisting motion. Be sure the button on the fairing mates with the recess in the transducer housing.

Installing

1. From outside the hull, thread the cable through the mounting hole. Then push the stem of the transducer through the hole using a twisting motion to squeeze out excess sealant. *Take care to align the transducer with the blunt/button/arrow end*

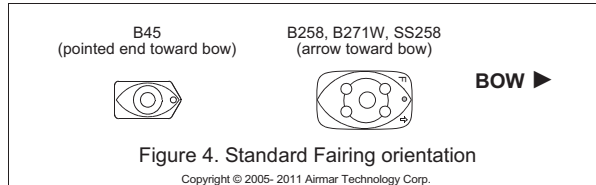

facing forward toward the bow. The long side must be parallel to the centerline of the boat (see Figure 4).

Stainless steel transducer in a metal hull —Be sure the isolation sleeve is between the transducer stem and the hull (see Figure 2). However, the isolation sleeve must be below the hull nut to prevent the sleeve from interfering with tightening the nut.

2. From inside the hull, slide the backing block (if installing with a fairing) and the hull nut onto the cable. Seat any backing block against the hull, being sure the arrow end faces forward toward the bow. Screw the hull nut in place and tighten it with slip-joint pliers (see Figures 4 and 5).

Cored fiberglass hull—Do not over-tighten, crushing the hull.
Wood hull—Allow for the wood to swell before tightening the nut.

3. Remove any excess marine sealant on the outside of the hull/fairing to ensure smooth water flow under the transducer.

Cable Routing & Connecting

CAUTION: If the sensor came with a connector, do not remove it to ease cable routing. If the cable must be cut and spliced, use Airmar's splash-proof Junction Box No. 33-035 and follow the instructions supplied. Removing the waterproof connector or cutting the cable, except when using a water-tight junction box, will void the sensor warranty.

1. Route the cable to the instrument being careful not to tear the cable jacket when passing it through the bulkhead(s) and other parts of the boat. Use grommet(s) to prevent chafing. To reduce electrical interference, separate the transducer cable from other electrical wiring and the engine. Coil any excess cable and secure it in place with cable ties to prevent damage.
2. Refer to the instrument owner's manual to connect the transducer to the instrument.

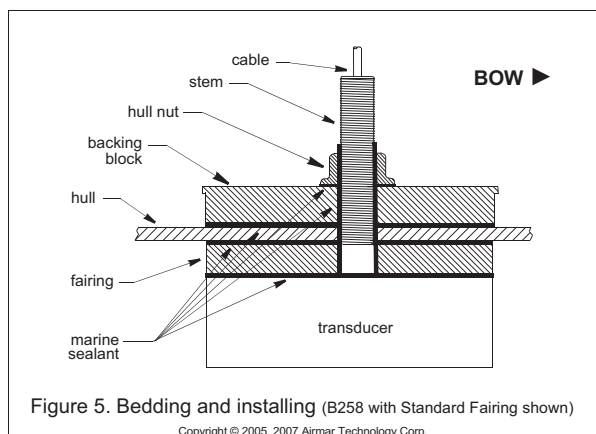

Checking for Leaks

When the boat is placed in the water, **immediately** check around the transducer for leaks. Note that very small leaks may not be readily observed. Do not leave the boat in the water for more than 3 hours before checking it again. If there is a small leak, there may be considerable bilge water accumulation after 24 hours. If a leak is observed, repeat "Bedding" and "Installing" **immediately** (see page 3).

Installation in a Cored Fiberglass Hull

The core (wood or foam) must be cut and sealed carefully. The core must be protected from water seepage, and the hull must be reinforced to prevent it from crushing under the hull nut, allowing the transducer to become loose.

CAUTION: Completely seal the hull to prevent water seepage into the core.

1. Drill a 3mm or 1/8" pilot hole perpendicular to the waterline from inside the hull (see Figure 6). If there is a rib, strut, or other hull irregularity near the selected mounting location, drill from the outside. (If the hole is drilled in the wrong location, drill a second hole in a better location. Apply masking tape to the outside of the hull over the incorrect hole and fill it with epoxy.)
2. Using the appropriate size drill bit, cut a hole from outside the hull through the *outer* skin only. *Be sure to hold the drill plumb, so the hole will be perpendicular to the water surface.*
3. The optimal interior hole diameter is affected by the hull's thickness and deadrise angle. It must be large enough in diameter to allow the core to be completely sealed. Using the appropriate size drill bit for the hull interior, cut through the *inner* skin and most of the core from inside the hull keeping the drill perpendicular to the hull. The core material can be very soft. Apply only light pressure to the drill bit after cutting through the *inner* skin to avoid accidentally cutting the *outer* skin.
4. Remove the plug of core material so the *inside* of the outer skin and the inner core of the hull is fully exposed. Sand and clean the inner skin, core, and the outer skin around the hole.

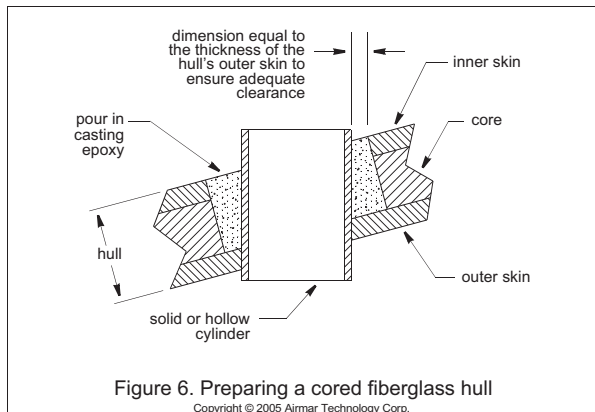

5. Coat a hollow or solid cylinder of the correct diameter with wax and tape it in place. Fill the gap between the cylinder and hull with casting epoxy. After the epoxy has set, remove the cylinder.
6. Sand and clean the area around the hole, inside and outside, to ensure that the sealant will adhere properly to the hull. If there is any petroleum residue inside the hull, remove it with either mild household detergent or a weak solvent (alcohol) before sanding.
7. Proceed with "Cutting the Standard Fairing" on page 2.

Anti-fouling Paint

Surfaces exposed to salt water must be coated with anti-fouling paint. Use **water-based** anti-fouling paint only. Never use ketone-based paint since ketones can attack many plastics possibly damaging the transducer. Reapply anti-fouling paint every 6 months or at the beginning of each boating season.

Maintenance, Parts & Replacement

Cleaning

Aquatic growth can accumulate rapidly on the transducer's surface reducing its performance within weeks. Clean the surface with a Scotch-Brite® scour pad and mild household detergent taking care to avoid making scratches. If the fouling is severe, lightly wet sand with fine grade wet/dry paper.

Replacement Transducer & Parts

The information needed to order a replacement transducer is printed on the cable tag. Do not remove this tag. When ordering, specify the part number, date, and frequency in kHz. For convenient reference, record this information on the top of page 1.

Lost, broken, and worn parts should be replaced immediately.

| Model | Hull Nut | Fairing Type | Fairing |
|------------------------|-----------|------------------|-----------|
| B45 | 02-031-3 | Standard | 33-351-01 |
| | | High-Performance | 33-509-01 |
| B258, B271W | 02-222-03 | Standard | 33-226-01 |
| | | High-Performance | 33-523-01 |
| B260 | 02-036-2 | High-Performance | 33-391-01 |
| B265LH/LM, B275LH-W | 02-036-2 | High-Performance | 33-391-01 |
| SS258 | 02-539-01 | Standard | 33-226-01 |
| | | High-Performance | 33-523-01 |
| SS260 | 02-036-03 | High-Performance | 33-391-01 |
| SS270W | 02-036-03 | High-Performance | 33-391-01 |
| SS505 | 02-111-01 | High-Performance | 33-355-01 |

Obtain parts from your instrument manufacturer or marine dealer.

| | |
|--|--|
| Gemeco (USA) | Tel: 803-693-0777 Fax: 803-693-0477 email: sales@gemeco.com |
| Airmar EMEA (Europe, Middle East, Africa) | Tel: +33.(0)2.23.52.06.48 Fax: +33.(0)2.23.52.06.49 email: sales@airmar-emea.com |



35 Meadowbrook Drive, Milford, New Hampshire 03055-4613, USA
•www.airmar.com

AVOID OVERHEATING

Installation Supplement: *Chirp Transducers*



CAUTION: Follow the instructions that came with your transducer. To install a Chirp transducer in a way other than intended by the manufacturer may lead to the transducer overheating, resulting in transducer failure.

Due to the nature of Chirp technology, Chirp transducers generate more heat than traditional tone-burst transducers operating at the same frequency. Chirp transducers have heat sinks in their construction to dissipate heat. Airmar's Chirp transducers have been designed to be installed in specific ways according to the number and placement of these heat sinks.

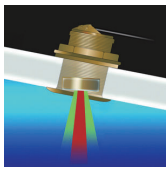

Thru-Hull Mount: Low-Profile

Models: B75L/M/H, B150M, B175L/M/H, B175HW, SS75L/M/H, SS175L/M/H, SS175HW

Transducer is installed in a hole drilled through the hull at a cool location away from the engine compartment. During operation, the active face of the transducer is in contact with water.

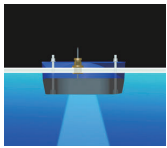

Thru-Hull Mount: External, Stem

Models: B265LH/LM, B275LHW, B285HW, B285M, B765LH/LM, B785M, M188LH, R109LH/LM, R109LHW, R409LWM, R509LH/LM, R509LHW

Transducer is installed entirely outside of the hull. A stem or stuffing tube hole is drilled through the hull for the transducer cable. The active face and sides of the transducer are immersed in water.



In-Hull Mount

Models: M135M, M265LH/LM, M285HW, P75M, P95M, P155M, R111LH/LM, R599LH/LM

Transducer is installed within a wetbox/yellow plastic tank affixed inside the hull at a cool location. It must be away from the engine compartment and other hot places. No holes are drilled in the hull, however this installation is suitable for a solid fiberglass hull only. The active face and the sides of the transducer are immersed in propylene glycol (non-toxic marine/RV anti-freeze).

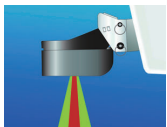

Transom Mount

Models: IC-TM90M, TM150M, TM165HW, TM185HW, TM185M, TM265LH/LM, TM275LHW

Transducer is bolted to the outside of the boat on the transom. During operation, the active face and sides of the transducer are immersed in water.

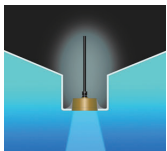

Keel Mount

Models: CM599L, CM599LH/LM, CM599LHW, PM111LH/LM, PM111LHW, PM265LH/LM, PM275LHW, PM411LWM

Transducer is fiberglassed into the keel at a cool location away from the engine compartment. The active face of the transducer is flush with the outside of the hull and in contact with water.

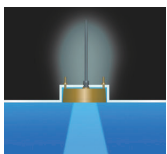

Pocket Mount

Models: CM599L, CM599LH/LM, CM599LHW, PM111LH/LM, PM111LHW, PM265LH/LM, PM275LHW, PM411LWM

Transducer is bolted into a fiberglass cavity formed in the hull at a cool location away from the engine compartment. The active face of the transducer is flush with the outside of the hull and in contact with water.

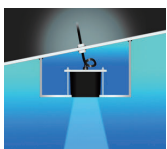

Welded-tank Mount

Models: CM265LH/LM, CM275LHW, CM599LH/LM, CM599LHW

Transducer is installed within a water-filled, welded tank outside of the hull. A stem or stuffing tube hole is drilled through the hull for the transducer cable. The active face and sides of the transducer are immersed in water.

APPX. 3 INSTALLATION OF TEMPERATURE SENSORS

The installation instructions in this chapter are copied from the manufacturer's (AIRMAR® Technology Corporation) installation guide, which is included with your sensor. The model numbers mentioned within the documentation should be read as follows:

- T42 → T-04MSB
- T80 → T-04MTB

OWNER'S GUIDE & INSTALLATION INSTRUCTIONS

Thru-Hull, Analog High-Precision Temperature Sensor

Model T42

Record the information found on the cable tag for future reference.

Part No. _____ Date _____

17-437-02 rev. 01
05/28/14

Follow the precautions below for optimal product performance and to reduce the risk of property damage, personal injury, and/or death.

WARNING: Always wear safety goggles and a dust mask when installing.

WARNING: Immediately check for leaks when the boat is placed in the water. Do not leave the boat unchecked for more than three hours. Even a small leak can allow considerable water to accumulate.

CAUTION: Never install a bronze sensor in a metal hull because electrolytic corrosion will occur.

CAUTION: Never install a metal sensor on a vessel with a positive ground system.

CAUTION: Never pull, carry, or hold the sensor by its cable; this may sever internal connections.

CAUTION: Never use solvents. Cleaner, fuel, sealant, paint, and other products may contain solvents that can damage plastic parts, especially the sensor's face.

IMPORTANT: Read the instructions completely before proceeding with the installation. These instructions supersede any other instructions in your instrument manual if they differ.

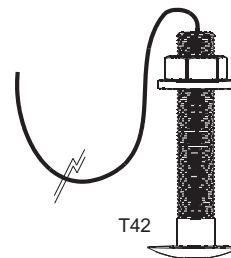

Tools & Materials

- Safety goggles
- Dust mask
- Electric drill
- Drill bit/hole saw/spade bit:
 - Pilot hole 3mm or 1/8"
 - T42 22mm or 7/8"
- Sandpaper
- Mild household detergent or weak solvent (alcohol)
- Marine sealant (suitable for below waterline)
- Slip-joint pliers
- Installation in a cored fiberglass hull (see page 2)
 - Hole saw for hull interior: 30mm or 1-1/4"
 - Cylinder, wax, tape, and casting epoxy
- Water-based anti-fouling paint (**mandatory in salt water**)

Sensor Installation

Hole Drilling

Cored fiberglass hull — Follow separate instructions on page 2.

1. Drill a 3mm or 1/8" pilot hole from inside the hull. If there is a rib, strut, or other hull irregularity near the selected mounting location, drill from the outside.
2. Using the appropriate drill bit, cut a hole perpendicular to the hull from outside the boat.
3. Sand and clean the area around the hole, inside and outside, to ensure that the marine sealant will adhere properly to the hull. If there is any petroleum residue inside the hull, remove it with either mild household detergent or a weak solvent (alcohol) before sanding.

Applications

- Bronze sensor recommended for fiberglass or wood hull only.
- The hull must be a minimum of 8mm (5/16") thick at the mounting location.

Mounting Location

Choose a location where the temperature sensor will be in contact with the water at all times.

APPX. 3 INSTALLATION OF TEMPERATURE SENSORS

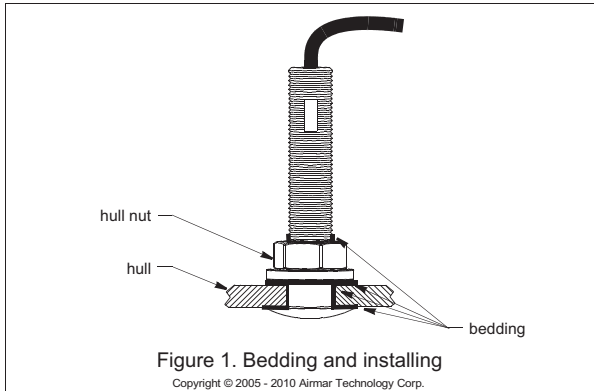

Bedding

CAUTION: Be sure all surfaces to be bedded are clean and dry.

1. Remove the hull nut (see Figure 1).
2. Apply a 2 mm (1/16") thick layer of marine sealant around the flange of the sensor that will contact the hull and up the stem. The sealant must extend 6mm (1/4") higher than the combined thickness of the hull and the hull nut. This will ensure that there is marine sealant in the threads to seal the hull and hold the hull nut securely in place.
3. Apply a 2 mm (1/16") thick layer of marine sealant to the flange of the hull nut that will contact the hull.

Installing

1. From outside the hull, thread the cable through the mounting hole.
2. Push the sensor into the mounting hole using a twisting motion to squeeze out excess marine sealant (see Figure 1).
3. From inside the hull, slide the hull nut onto the cable. Screw the hull nut in place. Tighten it with slip-joint pliers.
Cored fiberglass hull—Do not over tighten, crushing the hull.
Wood hull—Allow for the wood to swell before tightening.
4. Remove any excess marine sealant on the outside of the hull to ensure smooth water flow over the sensor.

Checking for Leaks

When the boat is placed in the water, **immediately** check around the thru-hull sensor for leaks. Note that very small leaks may not be readily observed. Do not leave the boat in the water for more than 3 hours before checking it again. If there is a small leak, there may be considerable bilge water accumulation after 24 hours. If a leak is observed, repeat "Bedding" and "Installing" **immediately** (see page 2).

Cable Routing & Connecting

CAUTION: If the sensor came with a connector, do not remove it to ease cable routing. If the cable must be cut and spliced, use Airmar's splash-proof Junction Box No. 33-035 and follow the instructions supplied. Removing the waterproof connector or cutting the cable, except when using a water-tight junction box, will void the sensor warranty.

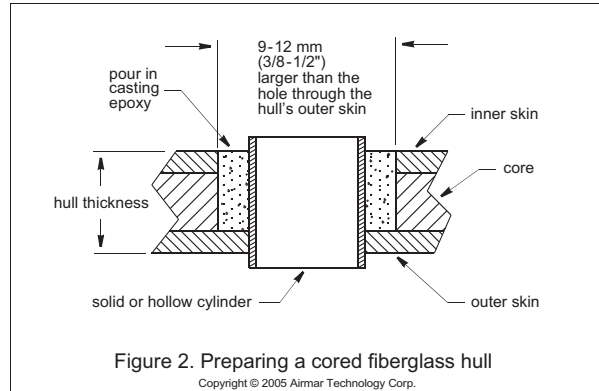

1. Route the cable to the instrument being careful not to tear the cable jacket when passing it through the bulkhead(s) and other parts of the boat. Use grommet(s) to prevent chafing. To reduce electrical interference, separate the transducer cable from other electrical wiring and the engine. Coil any excess cable and secure it in place with cable ties to prevent damage.
2. Refer to the instrument owner's manual to connect the transducer to the instrument.

Installation in a Cored Fiberglass Hull

The core (wood or foam) must be cut and sealed carefully. The core must be protected from water seepage, and the hull must be reinforced to prevent it from crushing under the hull nut allowing the sensor to become loose.

CAUTION: Completely seal the hull to prevent water seepage into the core.

1. Drill a 3mm or 1/8" pilot hole from inside the hull. If there is a rib, strut, or other hull irregularity near the selected mounting location, drill from the outside. (If the hole is drilled in the wrong location, drill a second hole in a better location. Apply masking tape to the outside of the hull over the incorrect hole and fill it with epoxy.)
2. Using the 21 mm or 7/8" drill bit, cut a hole from outside the hull through the *outer* skin only (see Figure 2).
3. From inside the hull using the 30mm or 1-1/4" hole saw, cut through the *inner* skin and most of the core. The core material can be very soft. Apply only light pressure to the hole saw after cutting through the inner skin to avoid accidentally cutting the *outer* skin.
4. Remove the plug of core material so the *inside* of the outer skin and the inner core of the hull is fully exposed. Clean and sand the inner skin, core, and the outer skin around the hole.
5. Coat a hollow or solid cylinder of the correct diameter with wax and tape it in place. Fill the gap between the cylinder and hull with casting epoxy. After the epoxy has set, remove the cylinder.
6. Sand and clean the area around the hole, inside and outside, to ensure that the sealant will adhere properly to the hull. If there is any petroleum residue inside the hull, remove it with either mild household detergent or a weak solvent (alcohol) before sanding.
7. Proceed with "Bedding" and "Installing" (see page 2).

Maintenance & Replacement

Aquatic growth can accumulate rapidly on the sensor's surface reducing its performance within weeks. Clean the surface with a Scotch-Brite® scour pad and mild household detergent taking care to avoid making scratches. If the fouling is severe, lightly wet sand with fine grade wet/dry paper.

Anti-fouling Paint

Surfaces exposed to salt water must be coated with anti-fouling paint. *Use water-based anti-fouling paint only.* Never use ketone-based paint since ketones can attack many plastics possibly damaging the sensor. Reapply anti-fouling paint every 6 months or at the beginning of each boating season.

Replacement Sensor & Parts

The information needed to order a replacement sensor is printed on the cable tag. Do not remove this tag. When ordering, specify the part number and date. For convenient reference, record this information at the top of page one.

Lost, broken, or worn parts should be replaced immediately.

Hull nut 02-031-3

Obtain parts from your instrument manufacturer or marine dealer.

Gemeco Tel: 803-693-0777
 (USA) Fax: 803-693-0477
 email: sales@gemeco.com

Airmar EMEA Tel: +33.(0)2.23.52.06.48
 (Europe, Middle East, Africa) Fax: +33.(0)2.23.52.06.49
 email: sales@airmar-emea.com

OWNER'S GUIDE & INSTALLATION INSTRUCTIONS

Surface Mount, Analog Temperature Sensor

Model T80

Record the information found on the cable tag for future reference.

Part No. _____ Date _____



05/28/14

17-584-01 rev. 01

Follow the precautions below for optimal product performance and to reduce the risk of property damage, personal injury, and/or death.

WARNING: Always wear safety goggles and a dust mask when installing.

WARNING: Below the waterline mount—When the boat is placed in the water, immediately check for leaks around the screws and any other holes drilled in the hull.

CAUTION: Installation on a metal hull—The stainless steel housing must be isolated from a metal hull to prevent electrolytic corrosion. Use marine sealant.

CAUTION: Never install a metal sensor on a vessel with a positive ground system.

IMPORTANT: Read the instructions completely before proceeding with the installation. These instructions supersede any other instructions in your instrument manual if they differ.

Tools & Materials

- Safety goggles
- Dust mask
- Pencil
- Electric drill
- Drill bit/hole saw/spade bit:
 - Pilot holes 3 mm or 1/8"
 - Transom hole (some installations) 18 mm or 3/4"
- 2 Stainless steel, self-tapping screws 4 x 18 mm or #8 x 3/4"
- Marine sealant (suitable for below waterline)
- Screwdriver(s)
- Cable clamp(s) (some installations)
- Grommet(s) (some installations)
- Cable ties

Installation

Mounting on the transom

CAUTION: Mount the sensor as close to the centerline (keel) of the boat as possible to ensure the sensor remains in the water when the boat is turning (see Figure 1).

CAUTION: Fiberglass hull—Minimize surface cracking by running the drill in reverse until the gelcoat is penetrated.

CAUTION: If the sensor came with a connector, do not remove it to ease cable routing. If the cable must be cut and spliced, use Airmar's splash-proof Junction Box No. 33-035 and follow the instructions provided. Removing the waterproof connector or cutting the cable, except when using a water-tight junction box, will void the sensor warranty.

Applications

- Measures air or water temperature.
- Stainless steel sensor is compatible with all hull materials. Recommended for aluminum hulls to prevent electrolytic corrosion, provided the stainless steel sensor is isolated from the metal hull by using marine sealant.

Mounting Location

The sensor can be mounted anywhere that you want to know the temperature. For example, you can mount the sensor on the transom, in the live well, or in the engine compartment.

If you are measuring water temperature, choose a location where the sensor will be in contact with the water at all times.

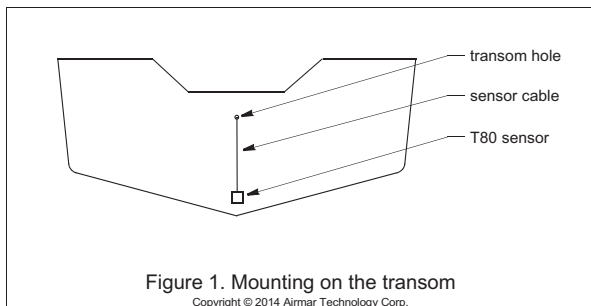

Mount the sensor near the centerline and close to the bottom of the transom.

Route the sensor cable over the transom, through a drain hole, or through a hole that you have drilled in the transom **above the waterline**.

1. Place the sensor against the hull and mark the position of the screw holes with a pencil.
2. Using a 3mm or 1/8" drill bit, drill pilot holes at the marked locations, 10mm (3/8") deep.
3. Apply marine sealant to the threads of the purchased screws to prevent water from seeping into the transom.
4. Screw the temperature sensor to the hull.
5. If a hole must be drilled through the transom, choose a location **well above the waterline**. Check for obstructions such as trim tabs, pumps, or wiring inside the hull. Mark the location with a pencil. Drill a hole through the transom using the appropriate size hole saw or spade bit (to accommodate the connector). Do NOT remove the connector.
6. Route the cable over or through the transom.
7. On the outside of the hull, secure the cable against the transom using a purchased cable clamp(s). Mark the position of the screw hole(s) with a pencil.
8. Using a 3mm or 1/8" drill bit, drill a pilot hole(s) at the marked locations, 10mm (3/8") deep.
9. Apply marine sealant to the threads of the screw(s) to prevent water from seeping into the transom.
10. Fasten the cable clamp(s) in place.
11. If a hole has been drilled through the transom, apply marine sealant to the space around the cable leading through the transom.

Cable Routing & Connecting

1. Route the cable to the instrument, being careful not to tear the cable jacket when passing it through the bulkhead(s) and other parts of the boat. To reduce electrical interference, separate the sensor cable from other electrical wiring and sources of noise. Coil any excess cable and secure it in place with cable ties to prevent damage.
2. Refer to the instrument owner's manual to connect the sensor to the instrument.

Replacement Sensor & Parts

The information needed to order a replacement sensor is printed on the cable tag. Do not remove this tag. When ordering, specify the part number and date. For convenient reference, record this information at the top of page one.

Obtain parts from your instrument manufacturer or marine dealer.

Gemeco
(USA)

Tel: 803-693-0777
 Fax: 803-693-0477
 email: sales@gemeco.com

Airmar EMEA
(Europe, Middle East, Africa)

Tel: +33.(0)2.23.52.06.48
 Fax: +33.(0)2.23.52.06.49
 email: sales@airmar-emea.com



35 Meadowbrook Drive, Milford, New Hampshire 03055-4613, USA
 •www.airmar.com

SPECIFICATIONS OF NETWORK FISH FINDER DFF1-UHD

1 GENERAL

- | | | |
|-----|-------------------|---|
| 1.1 | TX frequency | Selected from 42 to 65 kHz or 130 to 250 kHz, alternative transmission |
| 1.2 | Output power | 1 kW nominal |
| 1.3 | Amplifier type | Straight amplifier (H/L gain switching available) |
| 1.4 | Transmitting rate | 3000 pulse/min. or less |
| 1.5 | Depth range | 2 to 1200 m |
| 1.6 | Range shift | 1200 m max. |

2 INTERFACE

- | | | |
|-----|-------------------|----------------------------------|
| 2.1 | Number of ports | |
| | Network | 1 port |
| | Temp/speed sensor | 1 port |
| | External KP | 1 port (external KP kit: option) |
| 2.2 | Network method | Ethernet 10Base-T/100Base-TX |

3 POWER SUPPLY

- | | | |
|-----|---------------------------|--|
| 3.1 | Network fish finder | 12-24 VDC: 2.8-1.4 A |
| 3.2 | Rectifier (PR-62, option) | 100/110/220/230 VAC, 1 phase, 50/60 Hz |

4 ENVIRONMENTAL CONDITIONS

- | | | |
|-----|----------------------|----------------------|
| 4.1 | Ambient temperature | -15°C to +55°C |
| 4.2 | Relative humidity | 93% or less at +40°C |
| 4.3 | Degree of protection | IP55 |
| 4.4 | Vibration | IEC 60945 Ed.4 |

5 UNIT COLOR



- | | | |
|-----|---------------------|--------------|
| 5.1 | Network fish finder | N2.5 (fixed) |
|-----|---------------------|--------------|

PACKING LIST

02GL-X-9855 -0 1/1

DFF1-UHD (IP55)

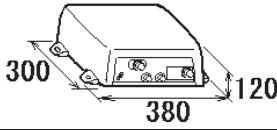
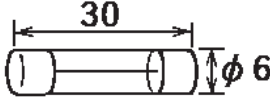
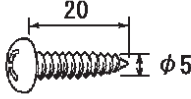
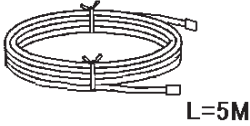
A-1

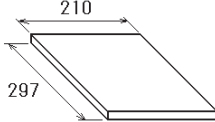
| NAME | OUTLINE | DESCRIPTION/CODE No. | QTY |
|--------------------------------------|---|------------------------|-----|
| ユニット UNIT | | | |
| ネットワーク魚探 NETWORK FISH FINDER |  | DFF1-UHD | 1 |
| | | 000-026-834-00 | |
| 予備品 SPARE PARTS | | | |
| ヒューズ GLASS TUBE FUSE |  | FGBO-A 125V 5A PBF | 2 |
| | | 000-155-853-10 | |
| 工事材料 INSTALLATION MATERIALS | | | |
| +トラスタップンネジ 1シユ SELF-TAPPING SCREW |  | 5X20 SUS304 | 4 |
| | | 000-162-608-10 | |
| ケーブル(組品)LAN LAN CABLE ASSEMBLY |  | MOD-Z072-050+ | 1 |
| | | 001-167-890-10 | |
| ケーブル組品MJ CABLE ASSEMBLY |  | MJ-A3SPF0013-035C (5A) | 1 |
| | | 000-157-939-10 | |
| 図書 DOCUMENT | | | |
| 取扱説明書 OPERATOR'S MANUAL |  | OM*-20400-* | 1 |
| | | 000-177-244-1* ** | |

コード番号末尾の[**]は、選択品の代表コードを表します。

CODE NUMBER ENDING WITH "**" INDICATES THE CODE NUMBER OF REPRESENTATIVE MATERIAL.

型式/コード番号が2段の場合、下段より上段に代わる過渡期品であり、どちらかが入っています。なお、品質は変わりません。

TWO TYPES AND CODES MAY BE LISTED FOR AN ITEM. THE LOWER PRODUCT MAY BE SHIPPED IN PLACE OF THE UPPER PRODUCT. QUALITY IS THE SAME.

(略図の寸法は、参考値です。DIMENSIONS IN DRAWING FOR REFERENCE ONLY.)

表1 TABLE 1

| 寸法区分 (mm) DIMENSION | 公差 (mm) TOLERANCE |
|------------------------|----------------------|
| L ≤ 50 | ±1.5 |
| 50 < L ≤ 100 | ±2.5 |
| 100 < L ≤ 500 | ±3 |

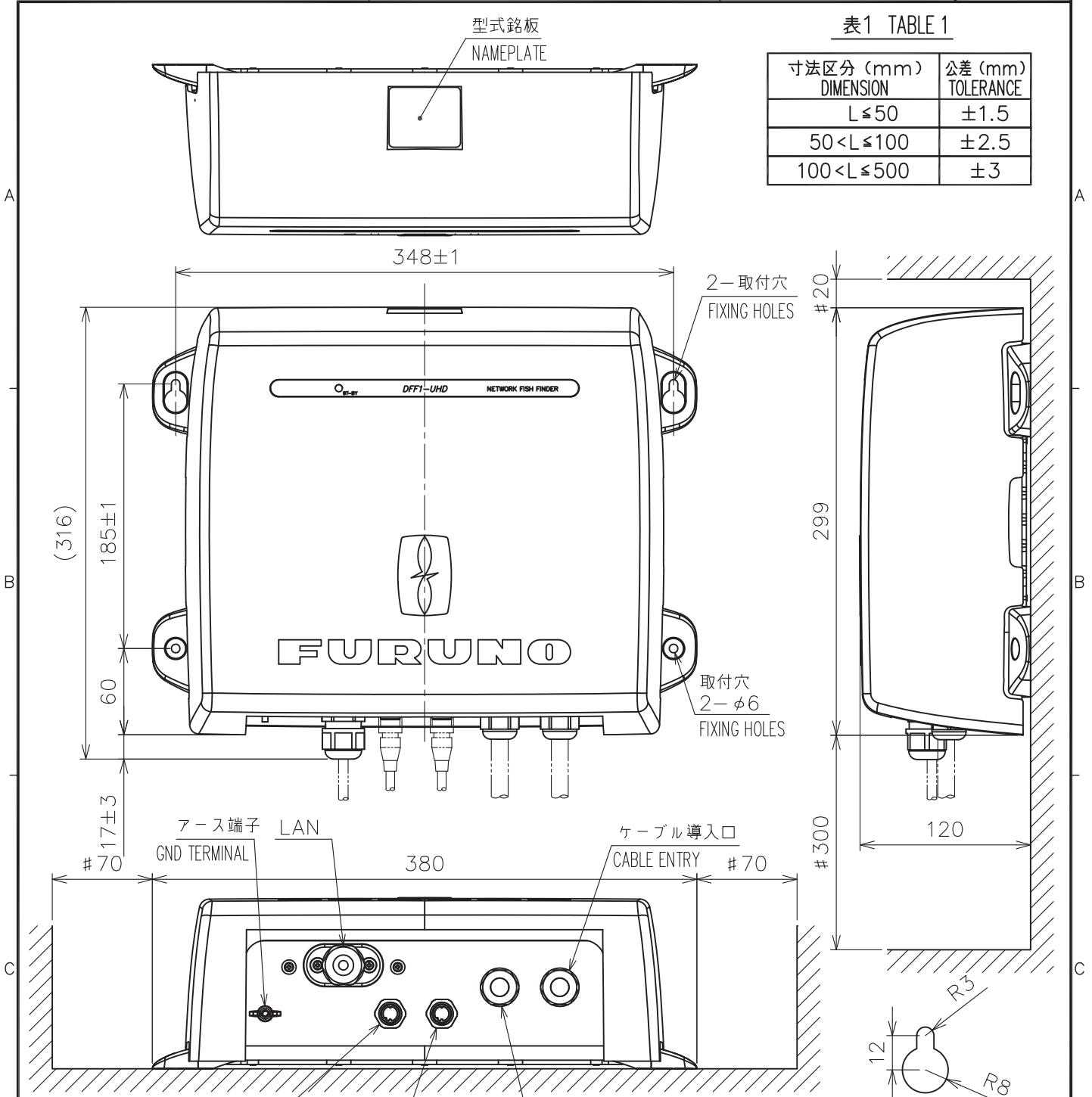

取付穴詳細 (尺度: 1/2)
DETAIL FOR FIXING (SCALE: 1/2)

- 注記
- 1) 指定外の寸法公差は表1による。
 - 2) #印寸法は最小サービス空間寸法とする。
 - 3) 取付用ネジはトラスタッピンネジ呼び径5×20を使用のこと。
 - 4) 壁掛時、ケーブルは下方のみとする。

- NOTE
1. TABLE 1 INDICATES TOLERANCE OF DIMENSIONS WHICH IS NOT SPECIFIED.
 2. #: MINIMUM SERVICE CLEARANCE.
 3. USE TAPPING SCREWS $\phi 5 \times 20$ FOR FIXING THE UNIT.
 4. FACE THE CABLES DOWNWARD FOR BULKHEAD MOUNTING.

| | | | |
|----------|-------------------------|-----------------|---------------------|
| DRAWN | 26/Aug/2014 I.YAMASAKI | TITLE | DFF1-UHD |
| CHECKED | 26/Aug/2014 H.MAKI | 名称 | ネットワーク魚探 |
| APPROVED | 26/Aug/2014 H.MAKI | 外寸図 | |
| SCALE | 1/4 MASS 3.2 ±10% kg | NAME | NETWORK FISH FINDER |
| DWG. No. | C2040-G01-C | REF. No. | 02-170-100G-4 |
| | | OUTLINE DRAWING | |

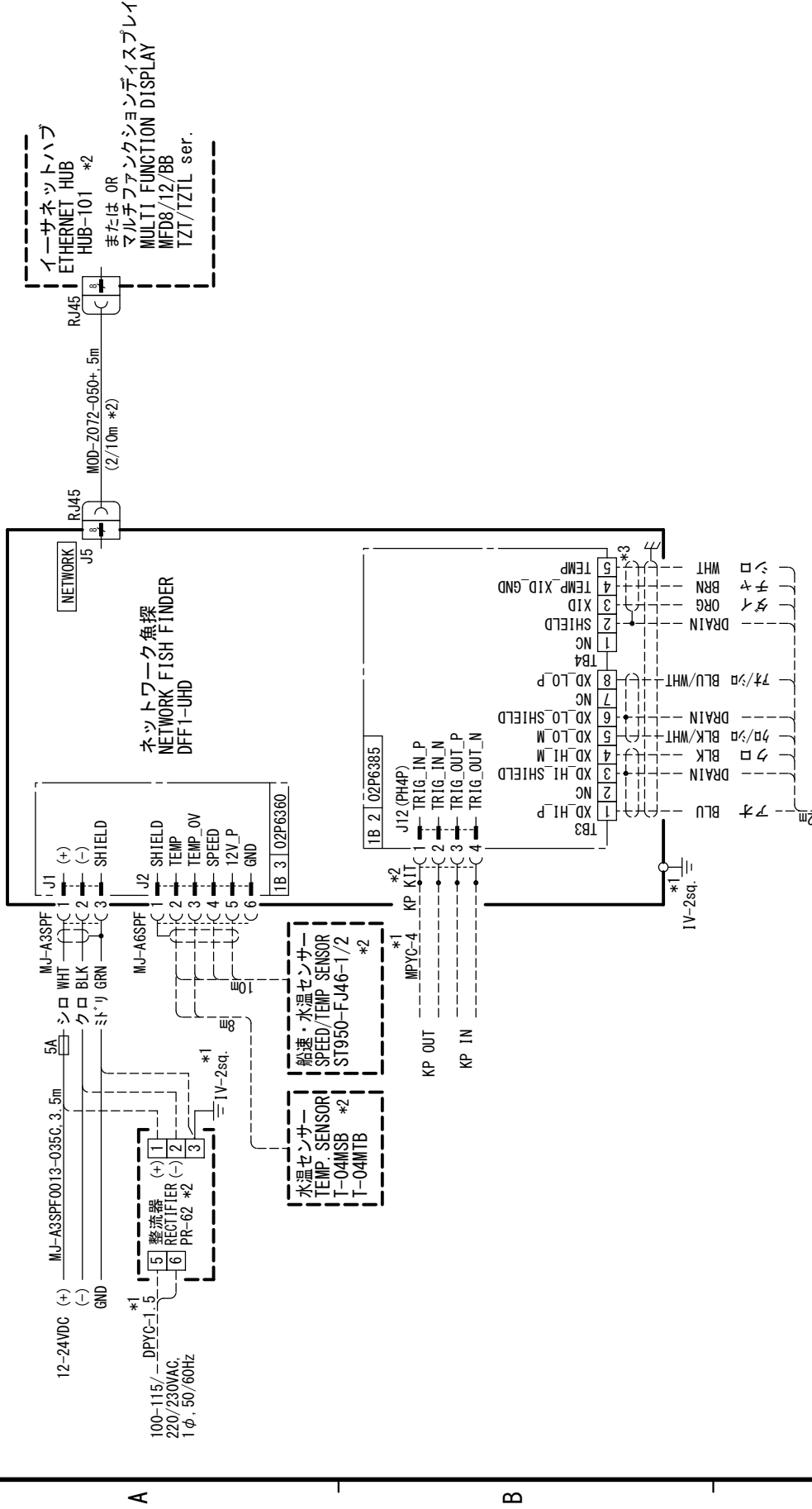

イーサネットハブ
ETHERNET HUB
HUB-101 *2
または OR
マルチファンクションディスプレイ
MULTI FUNCTION DISPLAY
MFD8/12/BB
TZ1/TZTL ser.

ネットワーク魚探
NETWORK FISH FINDER
DFF1-UHD

水温センサー
TEMP SENSOR
T-04MSB *2
T-04MTB

船速・水温センサー
SPEED/TEMP SENSOR
ST950-FJ46-1/2 *2

送波器
TRANSDUCER
B265LH *2
CM265LH
B275LH-W
CM275LH-W

- 注記
- *1) 造船所手配。
 - *2) オプション。
 - *3) CM265LHおよびCM275LH-Wのみ。
- NOTE
- *1: SHIPYARD SUPPLY.
 - *2: OPTION.
 - *3: FOR CM265LH AND CM275LH-W.

| | | | | |
|----------|-------------|-------------|---------------|-------------------------|
| DRAWN | 8/Feb/2023 | S. HAN | TITLE | DFF1-UHD |
| CHECKED | 8/Feb/2023 | T. YAMASAKI | 名称 | ネットワーク魚探 |
| APPROVED | 14/Feb/2023 | H. MAKI | | 相互結線図 |
| SCALE | 1/MASS | kg | NAME | NETWORK FISH FINDER |
| DWG. No. | C2040-C01-G | REF. No. | 02-167-1001-2 | INTERCONNECTION DIAGRAM |

FURUNO Worldwide Warranty for Pleasure Boats (Except North America)

This warranty is valid for products manufactured by Furuno Electric Co. (hereafter FURUNO) and installed on a pleasure boat. Any web based purchases that are imported into other countries by anyone other than a FURUNO certified dealer may not comply with local standards. FURUNO strongly recommends against importing these products from international websites as the imported product may not work correctly and may interfere with other electronic devices. The imported product may also be in breach of the local laws and mandated technical requirements. Products imported into other countries as described previously shall not be eligible for local warranty service.

For products purchased outside of your country please contact the national distributor of Furuno products in the country where purchased.

This warranty is in addition to the customer's statutory legal rights.

1. Terms and Conditions of Warranty

FURUNO guarantees that each new FURUNO product is the result of quality materials and workmanship. The warranty is valid for a period of 2 years (24 months) from the date of the invoice, or the date of commissioning of the product by the installing certified dealer.

2. FURUNO Standard Warranty

The FURUNO standard warranty covers spare parts and labour costs associated with a warranty claim, provided that the product is returned to a FURUNO national distributor by prepaid carrier.

The FURUNO standard warranty includes:

- Repair at a FURUNO national distributor
- All spare parts for the repair
- Cost for economical shipment to customer

3. FURUNO Onboard Warranty

If the product was installed/commissioned and registered by a certified FURUNO dealer, the customer has the right to the onboard warranty.

The FURUNO onboard warranty includes

- Free shipping of the necessary parts
- Labour: Normal working hours only
- Travel time: Up to a maximum of two (2) hours
- Travel distance: Up to a maximum of one hundred and sixty (160) KM by car for the complete journey

4. Warranty Registration

For the Standard Warranty - presentation of product with serial number (8 digits serial number, 1234-5678) is sufficient. Otherwise, the invoice with serial number, name and stamp of the dealer and date of purchase is shown.

For the Onboard Warranty your FURUNO certified dealer will take care of all registrations.

5. Warranty Claims

For the Standard Warranty - simply send the defective product together with the invoice to a FURUNO national distributor. For the Onboard Warranty – contact a FURUNO national distributor or a certified dealer. Give the product's serial number and describe the problem as accurately as possible.

Warranty repairs carried out by companies/persons other than a FURUNO national distributor or a certified dealer is not covered by this warranty.

6. Warranty Limitations

When a claim is made, FURUNO has a right to choose whether to repair the product or replace it.

The FURUNO warranty is only valid if the product was correctly installed and used. Therefore, it is necessary for the customer to comply with the instructions in the handbook. Problems which result from not complying with the instruction manual are not covered by the warranty.

FURUNO is not liable for any damage caused to the vessel by using a FURUNO product.

The following are excluded from this warranty:

- a. Second-hand product
- b. Underwater unit such as transducer and hull unit
- c. Routine maintenance, alignment and calibration services.
- d. Replacement of consumable parts such as fuses, lamps, recording papers, drive belts, cables, protective covers and batteries.
- e. Magnetron and MIC with more than 1000 transmitting hours or older than 12 months, whichever comes first.
- f. Costs associated with the replacement of a transducer (e.g. Crane, docking or diver etc.).
- g. Sea trial, test and evaluation or other demonstrations.
- h. Products repaired or altered by anyone other than the FURUNO national distributor or an authorized dealer.
- i. Products on which the serial number is altered, defaced or removed.
- j. Problems resulting from an accident, negligence, misuse, improper installation, vandalism or water penetration.
- k. Damage resulting from a force majeure or other natural catastrophe or calamity.
- l. Damage from shipping or transit.
- m. Software updates, except when deemed necessary and warrantable by FURUNO.
- n. Overtime, extra labour outside of normal hours such as weekend/holiday, and travel costs above the 160 KM allowance
- o. Operator familiarization and orientation.

FURUNO Electric Company, March 1, 2011

FURUNO Warranty for North America

FURUNO U.S.A., Limited Warranty provides a twenty-four (24) months LABOR and twenty-four (24) months PARTS warranty on products from the date of installation or purchase by the original owner. Products or components that are represented as being waterproof are guaranteed to be waterproof only for, and within the limits, of the warranty period stated above. The warranty start date may not exceed eighteen (18) months from the original date of purchase by dealer from Furuno USA and applies to new equipment installed and operated in accordance with Furuno USA's published instructions.

Magnetrons and Microwave devices will be warranted for a period of 12 months from date of original equipment installation.

Furuno U.S.A., Inc. warrants each new product to be of sound material and workmanship and through its authorized dealer will exchange any parts proven to be defective in material or workmanship under normal use at no charge for a period of 24 months from the date of installation or purchase.

Furuno U.S.A., Inc., through an authorized Furuno dealer will provide labor at no cost to replace defective parts, exclusive of routine maintenance or normal adjustments, for a period of 24 months from installation date provided the work is done by Furuno U.S.A., Inc. or an AUTHORIZED Furuno dealer during normal shop hours and within a radius of 50 miles of the shop location.

A suitable proof of purchase showing date of purchase, or installation certification must be available to Furuno U.S.A., Inc., or its authorized dealer at the time of request for warranty service.

This warranty is valid for installation of products manufactured by Furuno Electric Co. (hereafter FURUNO). Any purchases from brick and mortar or web-based resellers that are imported into other countries by anyone other than a FURUNO certified dealer, agent or subsidiary may not comply with local standards. FURUNO strongly recommends against importing these products from international websites or other resellers, as the imported product may not work correctly and may interfere with other electronic devices. The imported product may also be in breach of the local laws and mandated technical requirements. Products imported into other countries, as described previously, shall not be eligible for local warranty service.

For products purchased outside of your country please contact the national distributor of Furuno products in the country where purchased.

WARRANTY REGISTRATION AND INFORMATION

To register your product for warranty, as well as see the complete warranty guidelines and limitations, please visit www.furunousa.com and click on "Support". In order to expedite repairs, warranty service on Furuno equipment is provided through its authorized dealer network. If this is not possible or practical, please contact Furuno U.S.A., Inc. to arrange warranty service.

FURUNO U.S.A., INC.
Attention: Service Coordinator
4400 N.W. Pacific Rim Boulevard
Camas, WA 98607-9408
Telephone: (360) 834-9300
FAX: (360) 834-9400

Furuno U.S.A., Inc. is proud to supply you with the highest quality in Marine Electronics. We know you had several choices when making your selection of equipment, and from everyone at Furuno we thank you. Furuno takes great pride in customer service.



Declaration of Conformity



We **FURUNO ELECTRIC CO., LTD.**

(Manufacturer)

9-52 Ashihara-Cho, Nishinomiya City, 662-8580, Hyogo, Japan

(Address)

declare under our sole responsibility that the product

NETWORK FISH FINDER DFF1-UHD

(Model name, type number)

to which this declaration relates conforms to the following standard(s) or other normative document(s)

EU
EMC Directive 2014/30/EU

UK
SI 2016 No.1091 EMC Regulations 2016 as amended

IEC 60945 Ed.4.0: 2002

EN 60945: 2002

For assessment, see

- Test report
Furuno Labotech International Co., Ltd.
FLI 12-12-121, 19 Jan 2013

For assessment, see

- Test report
Furuno Labotech International Co., Ltd.
FLI 12-12-121, 19 Jan 2013

(title and/or number and date of issue of the standard(s) or other normative document(s))

On behalf of Furuno Electric Co., Ltd.

Nishinomiya City, Japan
26 July 2021

(Place and date of issue)

Akihiko Kanechika
Department General Manager
Quality Assurance Department

(name and signature or equivalent marking of authorized person)



FURUNO ELECTRIC CO., LTD.

9-52, Ashihara-cho,
Nishinomiya, 662-8580, JAPAN

·FURUNO Authorized Distributor/Dealer

All rights reserved. Printed in Japan

A: JAN. 2013
H2: SEP. 06, 2023

Pub. No. OME-20400-H2
(SEHA) DFF1-UHD

