

FURUNO

REMOTE DISPLAY

Model **RD-33**



 **FURUNO ELECTRIC CO., LTD.**

www.furuno.com



ECF
(Elemental Chlorine Free)
The paper used in this manual
is elemental chlorine free.

FURUNO ELECTRIC CO., LTD.

9-52, Ashihara-cho,
Nishinomiya, 662-8580, JAPAN

·FURUNO Authorized Distributor/Dealer

All rights reserved. Printed in Japan

A : JAN. 2010
E3 : MAY 13, 2021

Pub. No. OME-44590-E3
(YOTA) RD-33



IMPORTANT NOTICES

General

- This manual has been authored with simplified grammar, to meet the needs of international users.
- The operator of this equipment must read and follow the descriptions in this manual. Wrong operation or maintenance can void the warranty or cause injury.
- Do not copy any part of this manual without written permission from FURUNO.
- If this manual is lost or worn, contact your dealer about replacement.
- The contents of this manual and equipment specifications can change without notice.
- The example screens (or illustrations) shown in this manual can be different from the screens you see on your display. The screens you see depend on your system configuration and equipment settings.
- Save this manual for future reference.
- Any modification of the equipment (including software) by persons not authorized by FURUNO will void the warranty.
- The following concern acts as our importer in Europe, as defined in DECISION No 768/2008/EC.
 - Name: FURUNO EUROPE B.V.
 - Address: Ridderhaven 19B, 2984 BT Ridderkerk, The Netherlands
- The following concern acts as our importer in UK, as defined in SI 2016/1025 as amended SI 2019/470.
 - Name: FURUNO (UK) LTD.
 - Address: West Building Penner Road Havant Hampshire PO9 1QY, U.K.
- All brand, product names, trademarks, registered trademarks, and service marks belong to their respective holders.

How to discard this product

Discard this product according to local regulations for the disposal of industrial waste. For disposal in the USA, see the homepage of the Electronics Industries Alliance (<http://www.eiae.org/>) for the correct method of disposal.

How to discard a used battery

Some FURUNO products have a battery(ies). To see if your product has a battery, see the chapter on Maintenance. If a battery is used, tape the + and - terminals of the battery before disposal to prevent fire, heat generation caused by short circuit.

In the European Union

The crossed-out trash can symbol indicates that all types of batteries must not be discarded in standard trash, or at a trash site. Take the used batteries to a battery collection site according to your national legislation and the Batteries Directive 2006/66/EU.

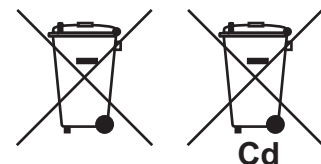

In the USA

The Mobius loop symbol (three chasing arrows) indicates that Ni-Cd and lead-acid rechargeable batteries must be recycled. Take the used batteries to a battery collection site according to local laws.

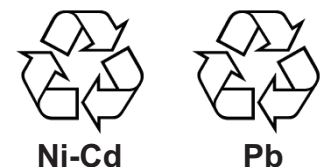

In the other countries

There are no international standards for the battery recycle symbol. The number of symbols can increase when the other countries make their own recycle symbols in the future.



SAFETY INSTRUCTIONS



WARNING

Indicates a condition that can cause death or serious injury if not avoided.



CAUTION

Indicates a condition that can cause minor or moderate injury if not avoided.

Safety Instructions for the Operator



WARNING



Do not open the equipment.

Only qualified persons can work inside the equipment.



Do not disassemble or modify the equipment.

Fire, electrical shock or serious injury can occur.



Turn off the power immediately if water leaks into the equipment or smoke or fire is coming from the equipment.

Failure to turn off the equipment can cause fire or electrical shock. Contact a FURUNO agent for service.



Keep heater away from the equipment.

Heat can change the equipment shape and melt the power cord, which can cause fire or electrical shock.



Do not use high-pressure cleaners to clean this equipment.

This equipment has the waterproof rating outlined in the specifications, at the back of this manual. However, the use of high-pressure cleaning equipment can cause water ingress, resulting in damage to, or failure of, the equipment.

Safety Instructions for the Installer



WARNING



Turn off the power at the switchboard before you install the equipment.

Fire or electrical shock can occur if the power is left on.



Be sure that the power supply is compatible with the voltage rating of the equipment.

Connection of an incorrect power supply can cause fire or equipment damage. The voltage rating of the equipment appears on the label above the power connector.



CAUTION



Ground the equipment to prevent mutual interference.

Observe the following compass safe distances to prevent interference to a magnetic compass:

Model	Standard compass	Steering compass
RD-33	0.60 m	0.40 m

TABLE OF CONTENTS

FOREWORD	v
SYSTEM CONFIGURATION	vi
1. BASIC OPERATION	1-1
1.1 Controls.....	1-1
1.2 How to Turn On/Off the Power.....	1-2
1.3 How to Adjust the Screen Brilliance/Key Dimmer.....	1-3
1.4 How to Step through the Data Screen.....	1-4
2. PROGRAMMED SCREEN	2-1
2.1 How to Set the Analog Screen Appearance.....	2-1
2.2 How to Set the Programmed Screen.....	2-2
2.3 How to Customize the Factory-preset Screen.....	2-10
3. CUSTOM SCREEN	3-1
3.1 How to Customize the Screen.....	3-1
3.2 Options for Categories.....	3-3
3.3 Data Screen.....	3-7
3.4 How to Set the Graph Display.....	3-8
3.4.1 How to enable auto range shift.....	3-8
3.4.2 How to set the period of the graph.....	3-9
3.5 How to Switch the Wind Mode and the Direction Mode.....	3-10
3.6 Stopwatch and Timer.....	3-11
3.7 Locked HDG/BRG.....	3-13
3.8 Cross-Track Error.....	3-15
3.9 How to Switch the Digital Data for Heading and Wind Angle.....	3-17
3.10 How to Reset the Value.....	3-18
3.11 Engine, Battery Status Icons.....	3-18
4. ALARMS	4-1
4.1 Overview.....	4-1
4.2 Audio Alarm Type.....	4-4
4.3 How to Set the Alarms.....	4-4
4.3.1 Arrival/Anchor alarm.....	4-4
4.3.2 XTE (Cross-Track Error) alarm.....	4-5
4.3.3 Speed (SOG/STW) alarm.....	4-5
4.3.4 Water temperature alarm.....	4-6
4.3.5 Depth alarm.....	4-8
4.3.6 Depth time out alarm.....	4-8
4.3.7 Trip/odometer alarm.....	4-9
4.3.8 Roll/pitch alarm.....	4-9
4.3.9 Other alarms.....	4-10
5. INPUT/OUTPUT SETUP	5-1
5.1 Received Data Status.....	5-1
5.2 CAN bus Devices Status.....	5-2
5.3 Data Source.....	5-3
5.4 NMEA0183 Output Mode.....	5-4
6. POSITION/TD SETUP, LAYLINES	6-1
6.1 Display Format for the Position of Your Ship.....	6-1
6.2 Laylines.....	6-2

TABLE OF CONTENTS

7. SYSTEM MENU	7-1
7.1 Units of Measurement	7-1
7.2 How to Set the Offset	7-2
7.3 Response Time	7-4
7.4 Scale Range.....	7-4
7.5 Setting for Time and Date	7-5
7.6 Other Menu Items	7-7
8. MAINTENANCE, TROUBLESHOOTING.....	8-1
8.1 Maintenance.....	8-1
8.2 Troubleshooting	8-2
8.3 Test	8-2
8.4 Factory Reset.....	8-4
8.5 Demo Mode.....	8-4
9. INSTALLATION	9-1
9.1 Equipment List	9-1
9.2 Installation	9-2
9.3 Wiring	9-4
9.4 Adjustments	9-7
9.5 Input/Output Signal	9-8
APPENDIX 1 MENU TREE	AP-1
APPENDIX 2 LIST OF TERMS	AP-4
SPECIFICATIONS	SP-1
INSTALLATION MATERIALS	A-1
OUTLINE DRAWINGS.....	D-1
INTERCONNECTION DIAGRAM	S-1
INDEX.....	IN-1

FOREWORD

A Word to the Owner of the RD-33 Remote Display

Congratulations on your choice of the FURUNO RD-33 Remote Display. We are confident you will see why the FURUNO name has become synonymous with quality and reliability.

Since 1948, FURUNO Electric Company has enjoyed an enviable reputation for innovative and dependable marine electronics equipment. This dedication to excellence is furthered by our extensive global network of agents and dealers.

Your equipment is designed and constructed to meet the rigorous demands of the marine environment. However, no machine can perform its intended function unless properly installed and maintained. Please carefully read and follow the operation and maintenance procedures set forth in this manual.

We would appreciate feedback from you, the end-user, about whether we are achieving our purposes.

Thank you for considering and purchasing FURUNO equipment.

Features

The main features of the RD-33 are as shown below.

- 4.3" color LCD is visible in direct sunlight (Nominal viewing distance: 0.6 m).
- Display the navigation data in digital, analog and graph formats.
- The design is consistent with NavNet 3D and FI-50, so there is uniformity in console installation.
- Fulfill the conversion function between CAN bus and NMEA 0183, so the RD-33 is in relay between existing equipments and CAN bus network.
- Alarm functions: Arrival/anchor watch, cross-track error, speed, water temperature, depth, depth time out, time, alarm clock, trip distance, odometer, roll, pitch, low battery, wind speed, wind angle.
- The frequently used data screens are set to default. Also, you can customize the data screens.

Program Number

Program	Number/Version	Date of Change
RD-33		
CPU Main	2651010-01.xx	Jan. 2010
CPU Boot	2651011-01.xx	Jan. 2010
CPU CAN LD	2651012-01.xx	Jan. 2010

xx: minor change

CE declaration

With regards to CE declarations, please refer to our website (www.furuno.com), for further information on RoHS conformity declarations.

SYSTEM CONFIGURATION

Single remote display

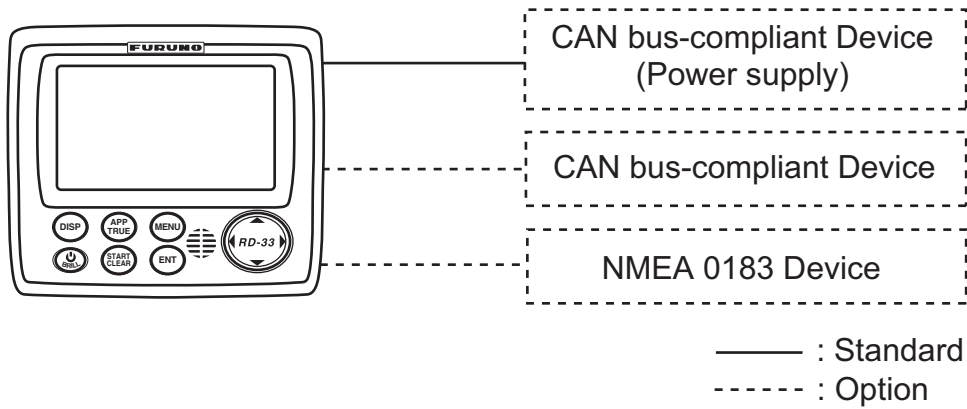

RD-33 and NavNet 3D connection

Up to three RD-33s can be connected on the CAN bus line.

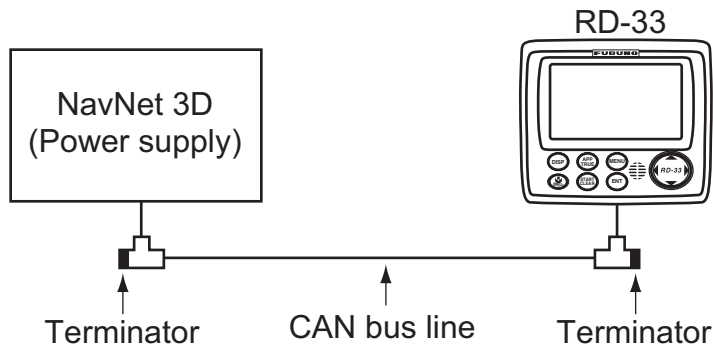

RD-33 and FI-50 connection

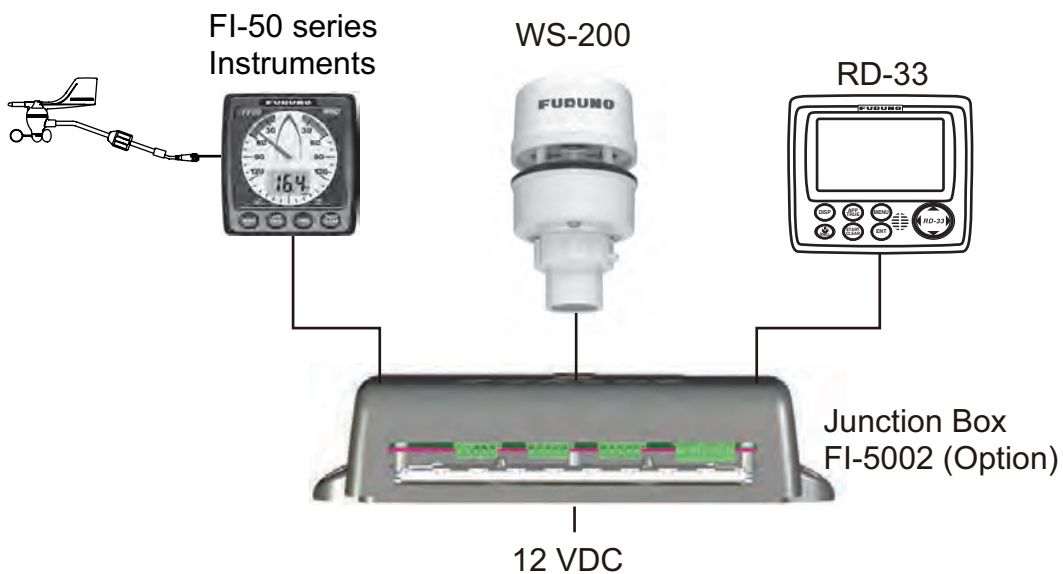

Daisy chain connection

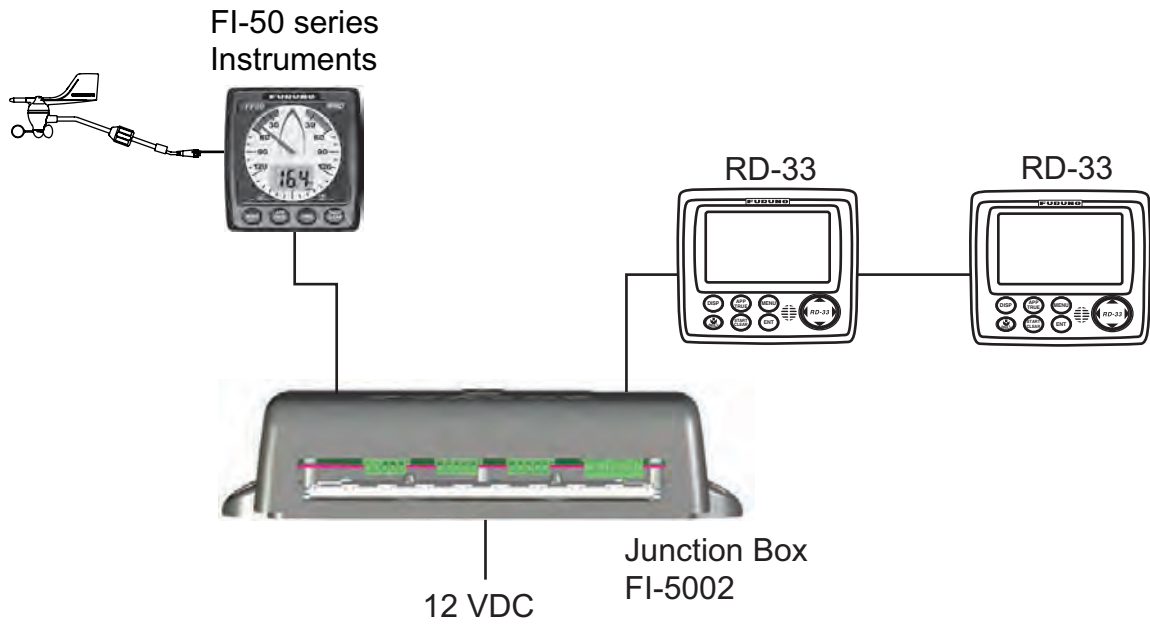

NMEA 0183, RD-33 and CAN bus device connection

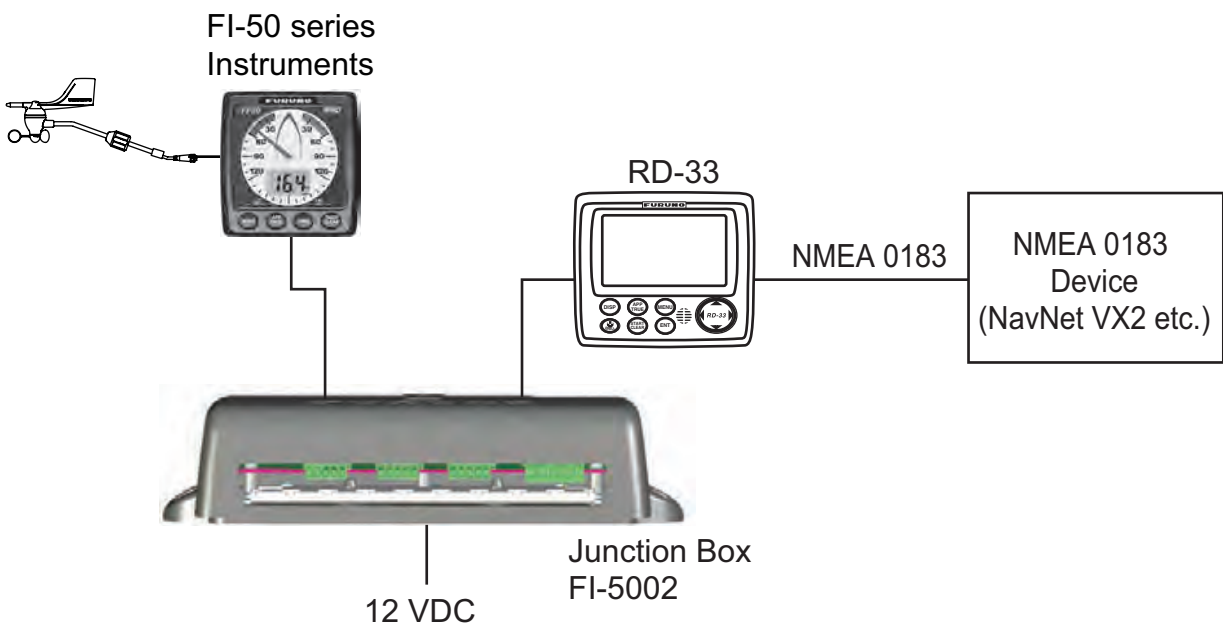

SYSTEM CONFIGURATION

Environmental category

RD-33	Protected from weather
FI-5002	

1. BASIC OPERATION

1.1 Controls

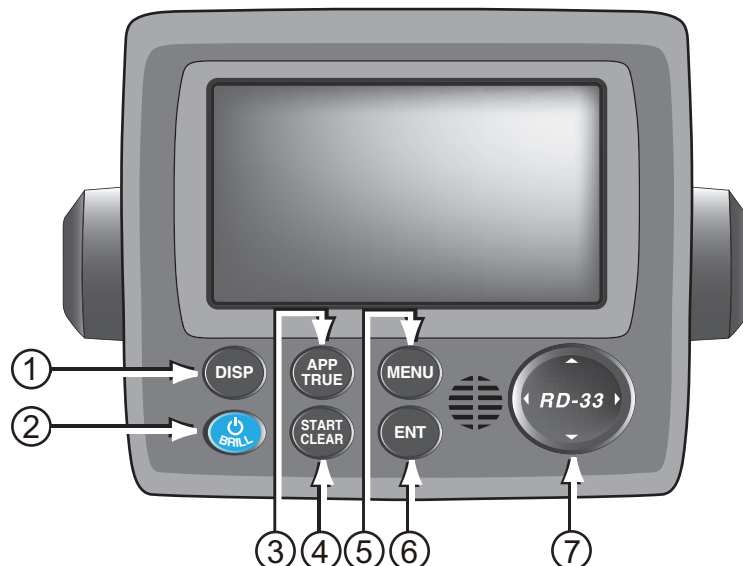

No.	Control	Main description
1	DISP	<p>Short press: Step through the seven data screens in the sequence of Display1 → Display2 → Display3 → Display4 → Display5 → Display6 → Display7 → Display1 → ...</p> <p>Long press: Step through the screens in reverse order.</p>
2	 /BRILL	<p>Short press: Turn on the power. Adjust the screen brilliance.</p> <p>Long press: Turn off the power.</p>
3	APP/TRUE	Switch the wind speed and direction between Apparent (APP) and True.
4	START/CLEAR	<p>At the data screen for [Stopwatch], [Timer1 (or 2)], [Locked HDG] or [Locked BRG],</p> <p>Short press:</p> <ul style="list-style-type: none"> • Start to count up/down the time. • Stop the timer (to measure lap time). • Display the locked heading/bearing. <p>Long press: Reset the value.</p>
5	MENU	<ul style="list-style-type: none"> • Open/close the menu. • Cancel last entry in menu operation and return one layer.
6	ENT	<ul style="list-style-type: none"> • Save selected menu option. • Move down one layer when you save the menu option in the layer except undermost one.
7	Cursorpad	<ul style="list-style-type: none"> • Select the menu items and options. • With the [Brill] window displayed, adjust the screen brilliance. (◀: Decrease, ▶: Increase) • With the [Brill] window displayed, adjust the key dimmer. (▲: Increase, ▼: Decrease)

How to remove the hard cover

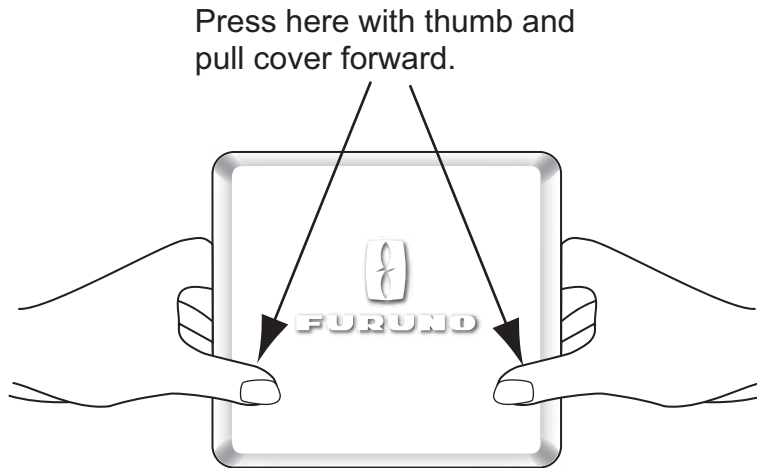

1.2 How to Turn On/Off the Power

Turn on the power

Press the  key to turn on the power. The start-up screen appears followed by the last-used data screen.

```
RD-33 Booter(1) ver.XX.XX (build:YYYY/MM/DD)
Program No: 2651011-XX.XX
Initializing...
Waiting for update request from SIO...
Waiting for update request from CAN...
Expanding program...
Starting program.
```

```
RD-33 ver.XX.XX (build:YYYY/MM/DD)
Program No: 2651010-XX.XX
Unique Number: ZZZZZ(ZZZZZZ)
CAN bus Module ver. XX.XX
Initializing...
Self Test
ROM      : OK
RAM      : OK
Starting program.
```

XX.XX: Program version number
YYYY/MM/DD: Date
Last used data screen

Turn off the power

Press and hold down the  key until the screen turns off. The following count-down window appears until the power goes off.

Turn Off in 3s.

1.3 How to Adjust the Screen Brilliance/Key Dimmer

You can adjust the screen brilliance and key dimmer as follows:

1. Press the  key momentarily to show the [Brill] window.

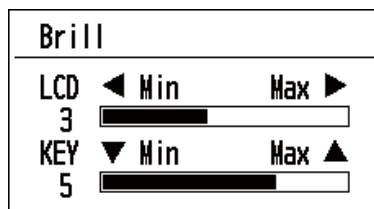

2. For the LCD brilliance, press the  key or use the Cursorpad (◀ or ▶) to adjust.
For the key brilliance, use the Cursorpad (▲ or ▼) to adjust.
3. Press the **MENU** key to close the window.

1.4 How to Step through the Data Screen

You can step through the seven data screens with the **DISP** key. When you press the **DISP** key momentarily, the screen changes in the sequence of Display1 → Display2 → Display3 → Display4 → Display5 → Display6 → Display7 → Display1 → ... The default screens are as shown below. For details, see sections 2.2 and 2.3.

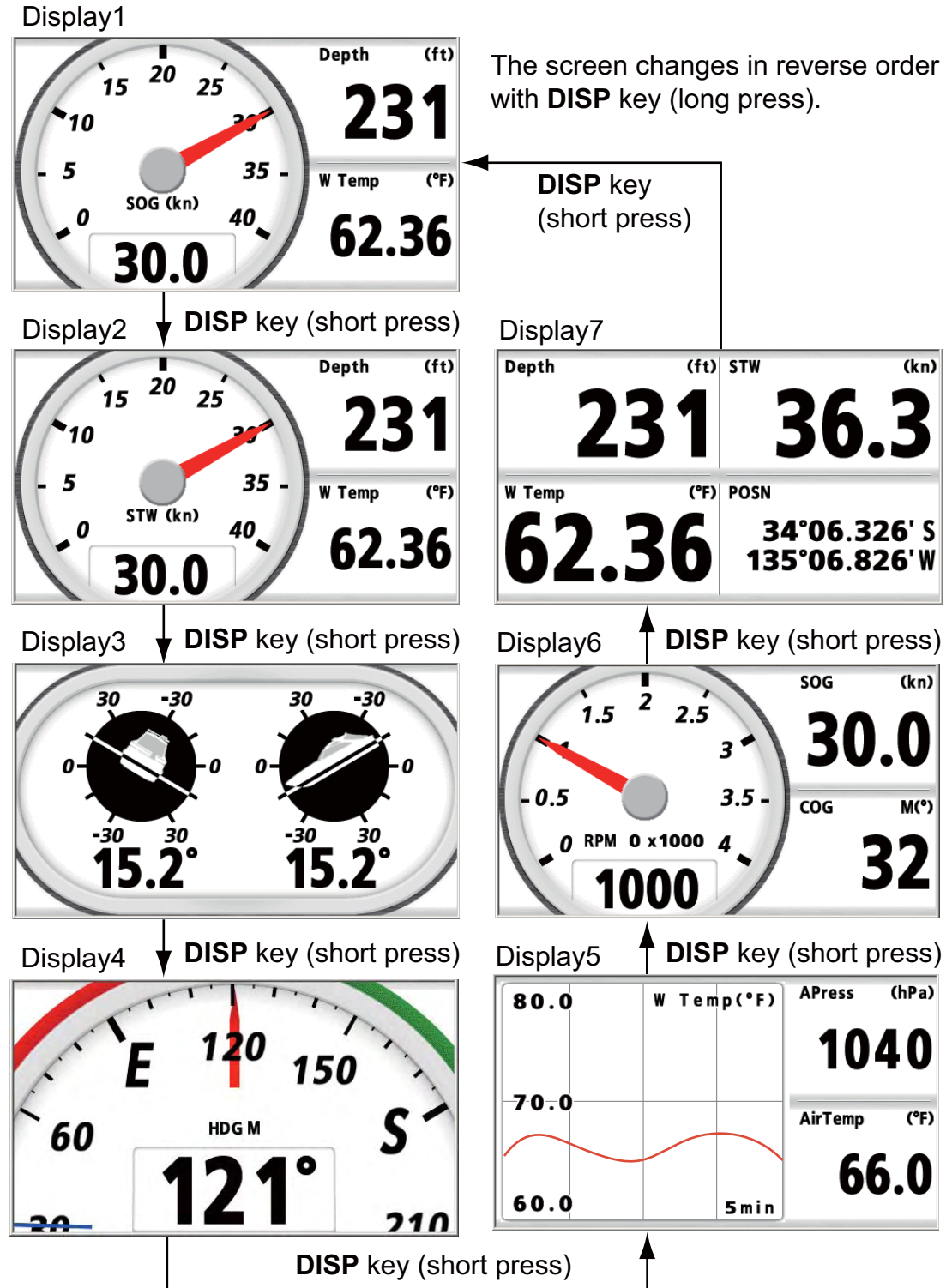

2. PROGRAMMED SCREEN

The RD-33 displays the data in three types; digital, analog and graph formats. Also, this equipment provides six programmed screen patterns which meets the purposes; [Fishing], [Sailing], [Ship], [Navigation], [Environment] and [Engine]. Availability of data depends on the sensors connected.

2.1 How to Set the Analog Screen Appearance

You can select the analog screen appearance from [A] and [B]. The font, background color, type of pointer (color, form), and so on differ between [A] and [B].

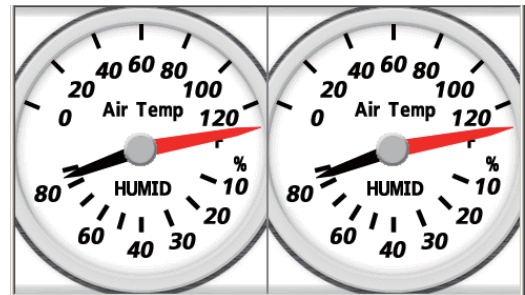
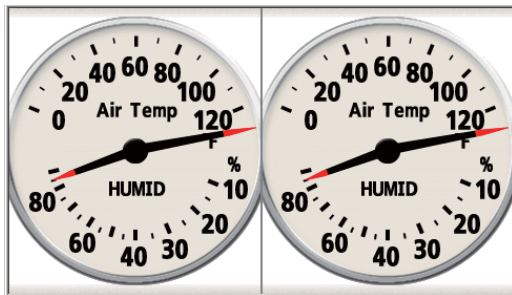
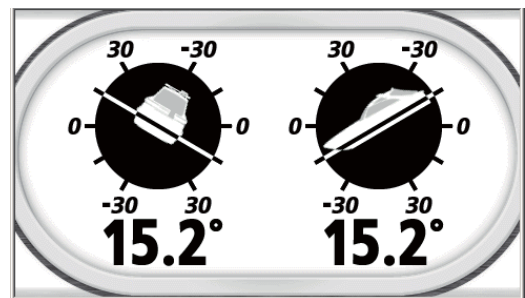
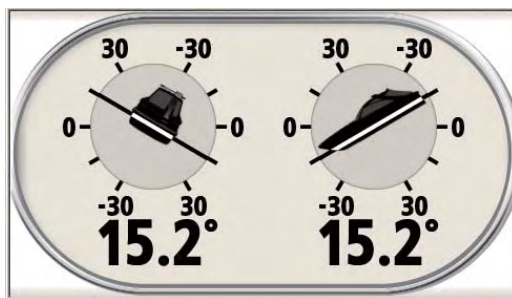

Example of [A]

Example of [B]

1. Press the **MENU** key to open the menu.

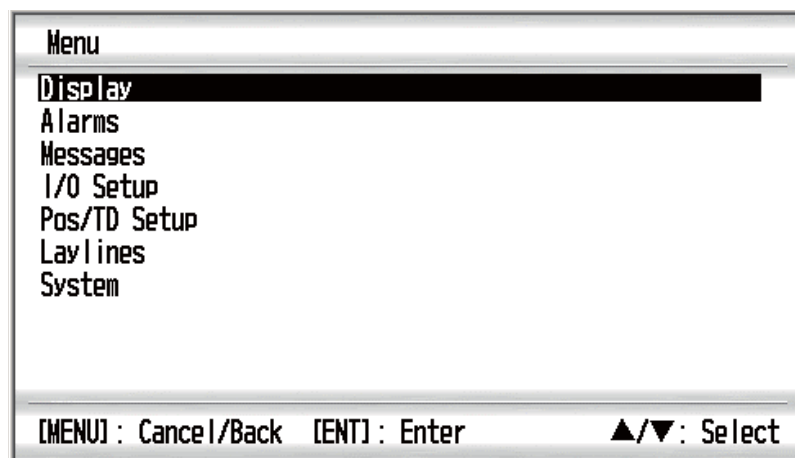

2. PROGRAMMED SCREEN

2. Use the Cursorpad (▲ or ▼) to select [Display] and press the **ENT** key.

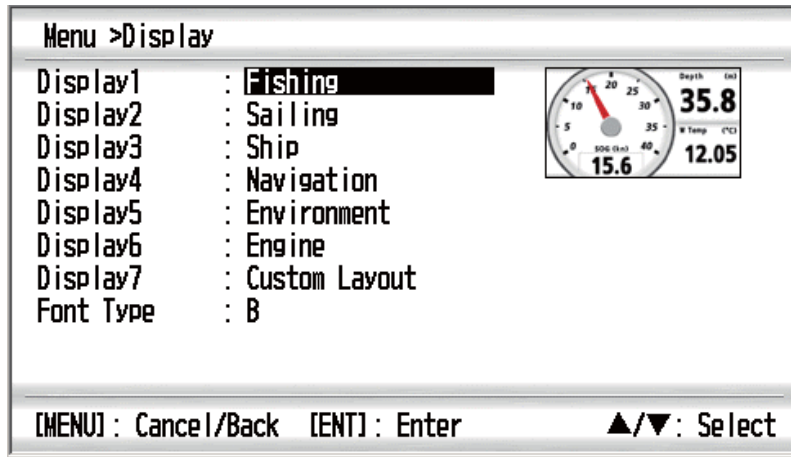

3. Use the Cursorpad (▲ or ▼) to select [Font Type] and press the **ENT** key.



4. Use the Cursorpad (▲ or ▼) to select [A] or [B] then press the **ENT** key.
5. Press the **DISP** key to close the menu and display the data screen.

2.2 How to Set the Programmed Screen

The RD-33 provides six programmed screens and each screen has four preset screens. You can select one of them as the data screen.

1. Press the **MENU** key to open the menu.
2. Use the Cursorpad (▲ or ▼) to select [Display] and press the **ENT** key.
3. Use the Cursorpad (▲ or ▼) to select [Display1] and press the **ENT** key.

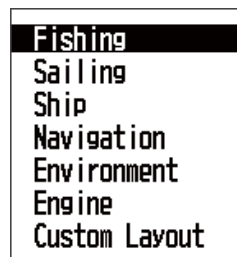

Display options for [Display1]

4. Use the Cursorpad (▲ or ▼) to select [Fishing], [Sailing], [Ship], [Navigation], [Environment] or [Engine] then press the **ENT** key. The data for these items are pre-set and arranged for general navigation purposes. See the table on page 2-4 for each menu item.

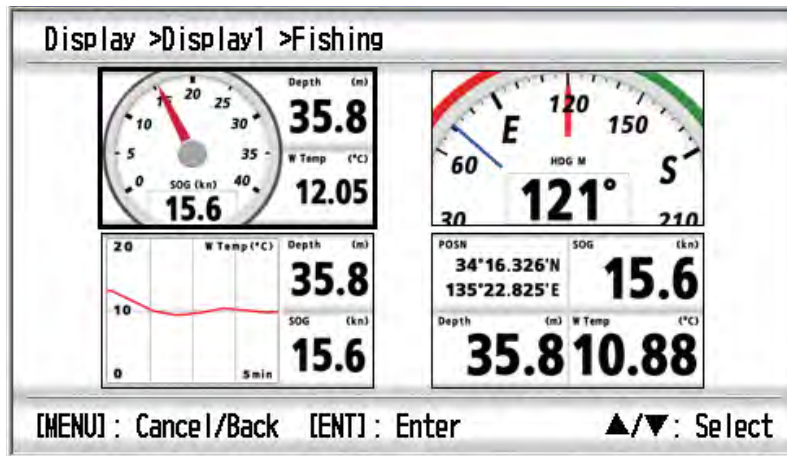

E.g. [Fishing] screen

Note: For [Custom Layout], see the next chapter.

5. Use the Cursorpad to select the screen desired and press the **ENT** key.
6. Select the screen for [Display2] to [Display7] in the same method.

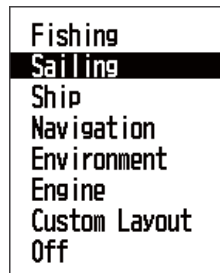

Display options for [Display2] to [Display7]



Note: If you selected [Off] on the [Display2] to [Display7], the data screen is skipped by pressing the **DISP** key.

7. Press the **DISP** key to close the menu and display the data screen.

2. PROGRAMMED SCREEN

Programmed screen patterns

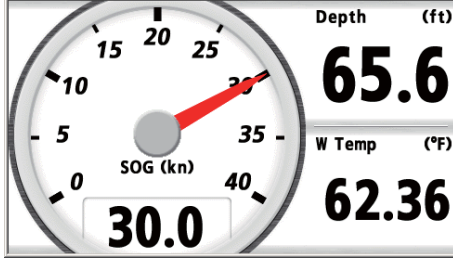
Note: For explanation of abbreviations shown on the screen, see APPENDIX 2.

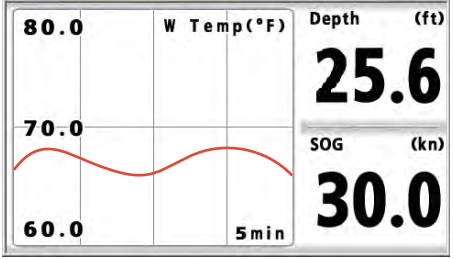
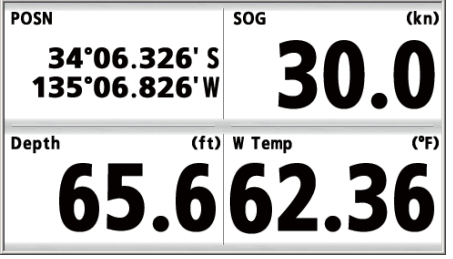
Menu item	Description	Screen
Fishing	<p>The screen for fishing.</p> <p>Pattern 1: SOG (Analog meter for Speed Over the Ground), Depth, W Temp (Water temperature)</p>	 <p>Pattern 1</p>
	<p>Pattern 2: HDG (Heading meter) (Blue line: COG)</p>	 <p>Pattern 2</p>
	<p>Pattern 3: W Temp (Water temperature graph), Depth, SOG (Speed Over the Ground)</p>	 <p>Pattern 3</p>
	<p>Pattern 4: POSN (Position), SOG (Speed Over the Ground), Depth, W Temp (Water temperature)</p>	 <p>Pattern 4</p>

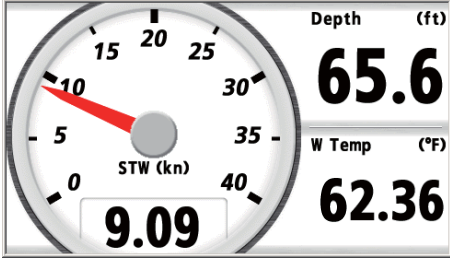
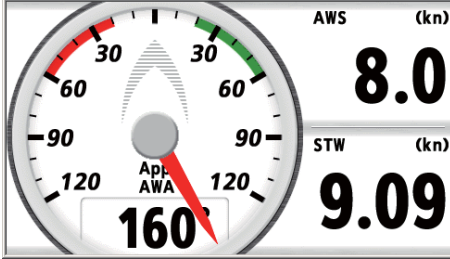
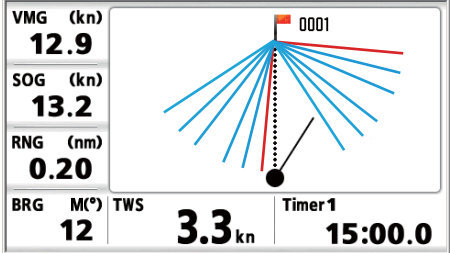
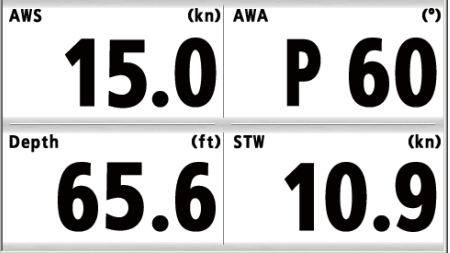
Menu item	Description	Screen
Sailing	<p>The screen for sailing.</p> <p>Pattern 1: STW (Analog meter for Speed Through the Water), Depth, W Temp (Water temperature)</p>	 <p>Pattern 1</p>
	<p>Pattern 2: AWA (Analog meter for Apparent Wind Angle), AWS (Apparent Wind Speed), STW (Speed Through the Water)</p>	 <p>Pattern 2</p>
	<p>Pattern 3: VMG (Velocity Made Good), SOG (Speed Over the Ground), RNG (Range), BRG (Bearing), TWS (True Wind Speed), Timer1 (Count down timer), Laylines</p>	 <p>Pattern 3</p>
	<p>Pattern: 4 AWS (Apparent Wind Speed), AWA (Apparent Wind Angle), Depth, STW (Speed Through the Water)</p>	 <p>Pattern 4</p>

2. PROGRAMMED SCREEN

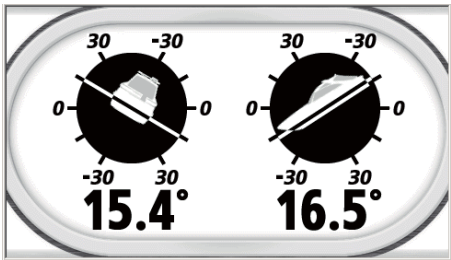
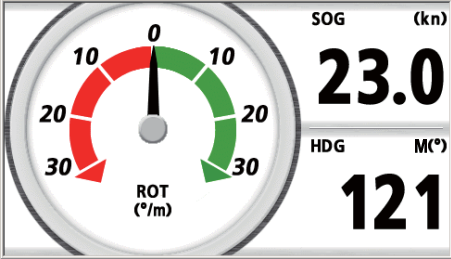
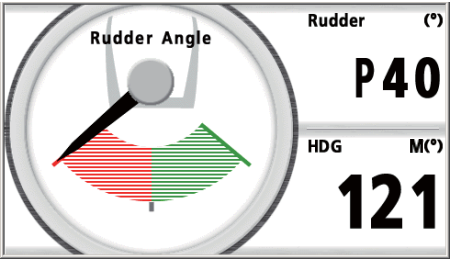
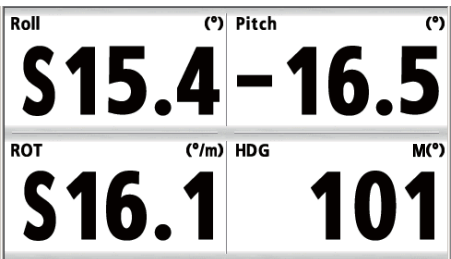
Menu item	Description	Screen
Ship	<p>The screen for ship data.</p> <p>Pattern 1: Roll/Pitch (Analog meter for Roll and Pitch)</p>	 <p>Pattern 1</p>
	<p>Pattern 2: ROT (Analog meter for Rate Of Turn), SOG (Speed Over the Ground), HDG (Heading)</p>	 <p>Pattern 2</p>
	<p>Pattern 3: Rudder Angle (Analog meter for rudder angle), Rudder (Rudder angle), HDG (Heading)</p>	 <p>Pattern 3</p>
	<p>Pattern 4: Roll, Pitch, ROT (Rate Of Turn), HDG (Heading)</p>	 <p>Pattern 4</p>

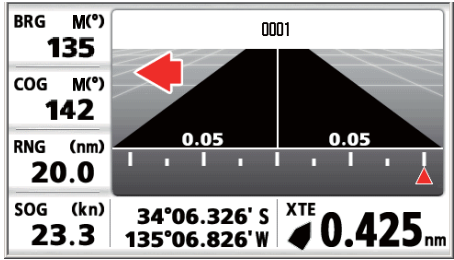
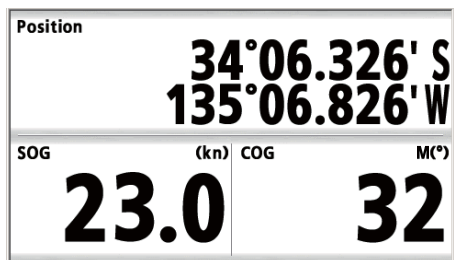
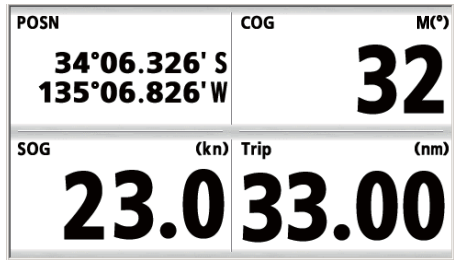
Menu item	Description	Screen
<p>Navigation</p>	<p>The screen for navigation.</p> <p>Pattern 1: HDG (Heading meter) (Blue line: COG)</p>	 <p>Pattern 1</p>
	<p>Pattern 2: BRG (Bearing), COG (Course Over the Ground), RNG (Range), SOG (Speed Over the Ground), Position (Latitude/Longitude), XTE (Cross-track Error), Highway screen</p>	 <p>Pattern 2</p>
	<p>Pattern 3: Position (Latitude/Longitude), SOG (Speed Over the Ground), COG (Course Over the Ground)</p>	 <p>Pattern 3</p>
	<p>Pattern 4: POSN (Position), COG (Course Over the Ground), SOG (Speed Over the Ground), Trip (Trip distance)</p>	 <p>Pattern 4</p>

2. PROGRAMMED SCREEN

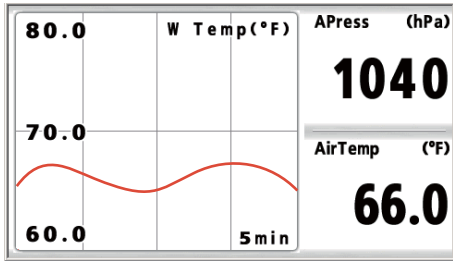
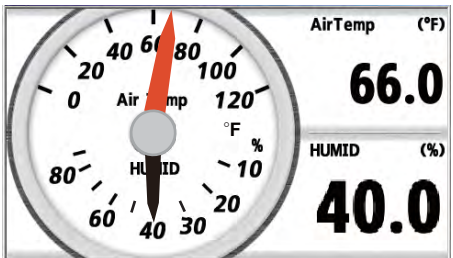
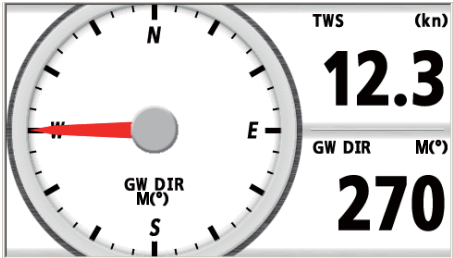
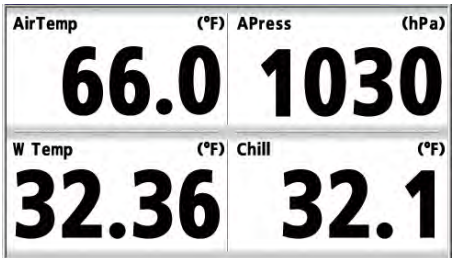
Menu item	Description	Screen
<p>Environment</p> <p>The screen for environment.</p> <p>Pattern 1: W Temp (Water temperature graph), APress (Air pressure), Air Temp (Air temperature)</p> <p>Pattern 2: Air Temp/HUMID (Analog meter for air temperature and humidity), Air Temp (Air temperature), HUMID (Humidity)</p> <p>Pattern 3: GW DIR (Analog meter for Ground Wind direction), TWS (True Wind Speed), GW DIR (Ground Wind direction)</p> <p>Pattern 4: Air Temp (Air temperature), APress (Air pressure), W Temp (Water temperature), Chill (Wind chill temperature)</p>		
		<p>Pattern 1</p> 
		<p>Pattern 2</p> 
		<p>Pattern 3</p> 
		<p>Pattern 4</p>

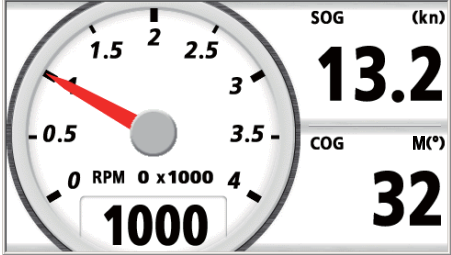
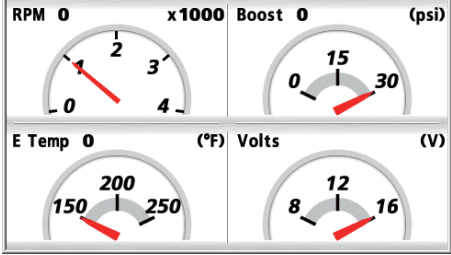
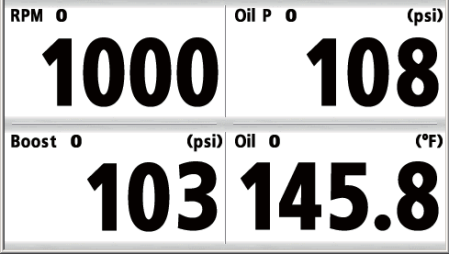
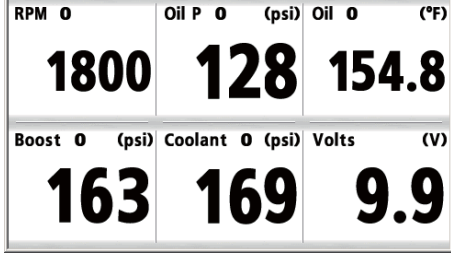
Menu item	Description	Screen
<p>Engine</p>	<p>The screen for engine.</p> <p>Pattern 1: RPM (Analog meter for Engine Revolutions Per Minute), SOG (Speed Over the Ground), COG (Course Over the Ground)</p> <p>Pattern 2: RPM (Analog meter for Engine Revolutions Per Minute), Boost (Analog meter for engine boost pressure), E Temp (Analog meter for engine temperature), Volts (Analog meter for input voltage)</p> <p>Pattern 3: RPM (Engine Revolutions Per Minute), Oil P (Engine oil pressure), Boost (Engine boost pressure), Oil (Engine oil temperature)</p> <p>Pattern 4: RPM (Engine Revolutions Per Minute), Oil P (Engine oil pressure), Oil (Engine oil temperature), Boost (Engine boost pressure), Coolant (Engine coolant pressure), Volts (Input voltage)</p>	 <p style="text-align: center;">Pattern 1</p>  <p style="text-align: center;">Pattern 2</p>  <p style="text-align: center;">Pattern 3</p>  <p style="text-align: center;">Pattern 4</p>

2.3 How to Customize the Factory-preset Screen

You can change the settings of the factory-preset data screen.

How to change the display item

1. With the data screen displayed, press the **ENT** key. The screen changes as below.

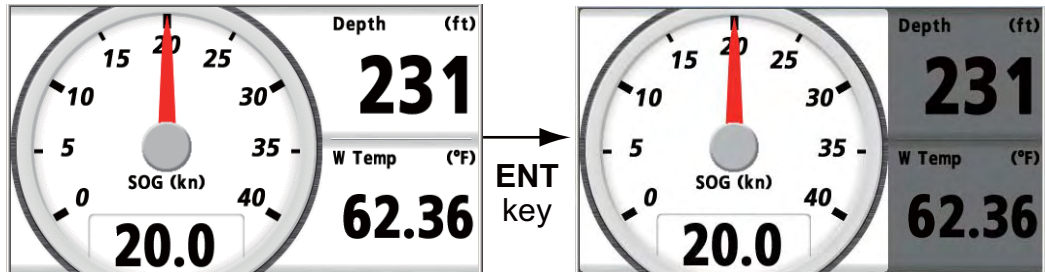

E.g. [Fishing] screen pattern 1

2. Use the Cursorpad to select the data box you want to change. The selected data box remains undarkened and the unselected data boxes darken.

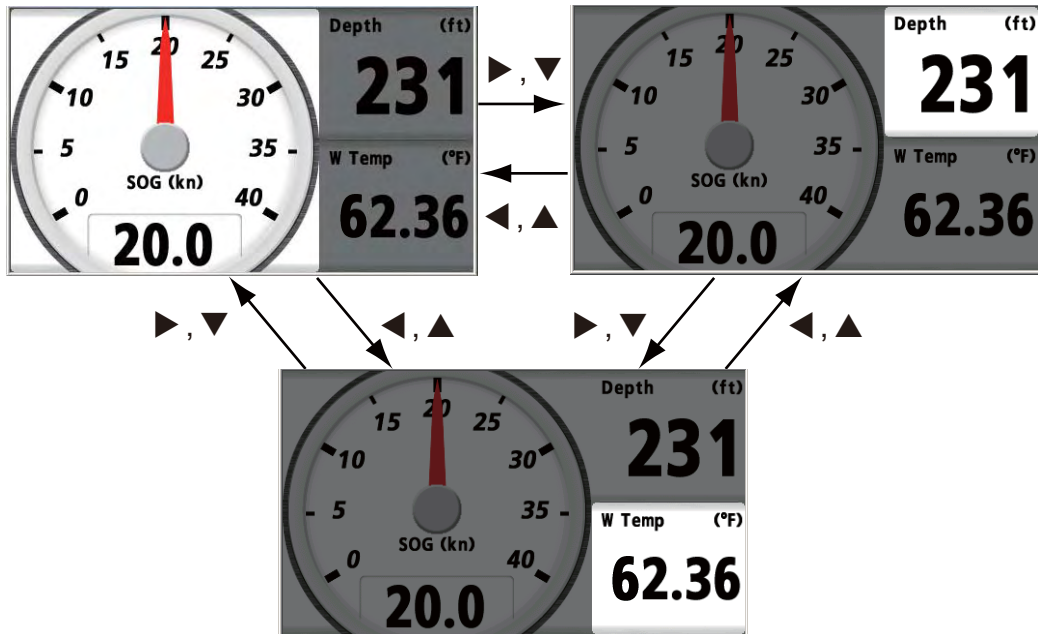

3. Press the **ENT** key.

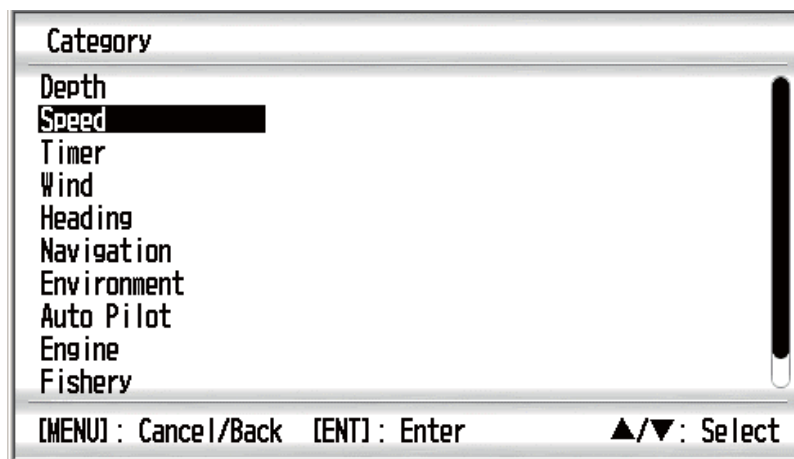

- Use the Cursorpad (▲ or ▼) to select the category and press the **ENT** key. The category options screen, which differs depending on the selected category, appears.

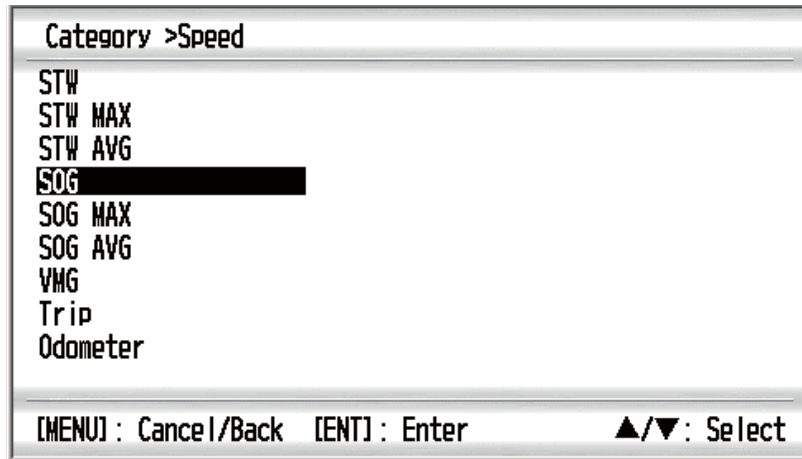

Category options (e.g. [Speed] category)

Note 1: If you selected [None] in the category list, the data screen is blank.

Note 2: For details of each category, see section 3.2.

Note 3: The available category and category options depend on the selected screen division. The unavailable category and category options are displayed in gray.

- Use the Cursorpad (▲ or ▼) to select an option and press the **ENT** key.

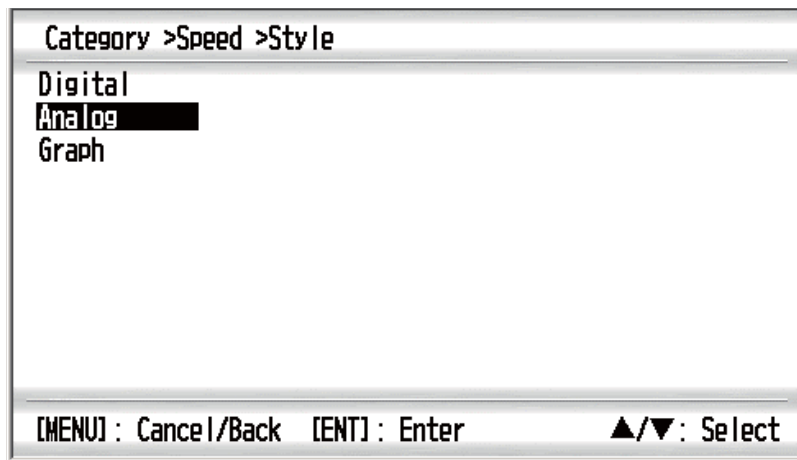

Note: Unavailable style options are displayed in gray.

- Use the Cursorpad (▲ or ▼) to select [Digital], [Analog] or [Graph] then press the **ENT** key.

How to change the properties

- With the data screen displayed, press the **ENT** key. For the no-split screen, go to step 3.
- Use the Cursorpad to select the data box you want to change.
- Press the **ENT** key long. The window for properties appears. The content differs according to the display item.

Note: When there are no properties, the screen returns to the previous data screen.

2. PROGRAMMED SCREEN

SOG		
Unit	:	kn
Response Time	:	0s
Alarm	:	Off
		10.0kn
		30.0kn
Style	:	Analog
Scale Range	:	0-40kn
Scale (Start From)	:	0kn
Scale (Max Range)	:	20kn
Period	:	5min

[MENU] : Cancel/Back [ENT] : Enter ▲/▼ : Select

E.g. SOG properties window

- Use the Cursorpad (▲ or ▼) to select an option and press the **ENT** key.

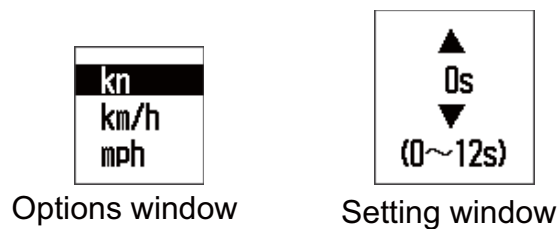

Window examples

- Use the Cursorpad (▲ or ▼) to select an option or numeric value then press the **ENT** key.
- Repeat steps 4 and 5 to set the other options if necessary.
- Press the **DISP** key or the **MENU** key to close the menu and display the data screen.

How to change the custom layout

- With the data screen displayed, press the **ENT** key long.

Display1
Fishing
Sailing
Ship
Navigation
Environment
Engine
Custom Layout

[MENU] : Cancel/Back [ENT] : Enter ▲/▼ : Select

- Do steps 4 to 5 at section 2.2.

3. CUSTOM SCREEN

You can arrange the data to display and show the data in the order desired. Availability of data depends on the sensors connected.

3.1 How to Customize the Screen

1. Press the **MENU** key to open the menu.
2. Use the Cursorpad (**▲** or **▼**) to select [Display] and press the **ENT** key.
3. Use the Cursorpad (**▲** or **▼**) to select [Display1 (2, 3, 4, 5, 6 or 7)] and press the **ENT** key.

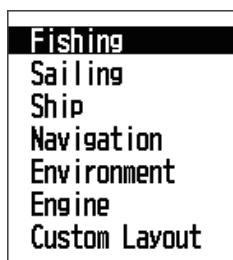

4. Use the Cursorpad (**▲** or **▼**) to select [Custom Layout] and press the **ENT** key.

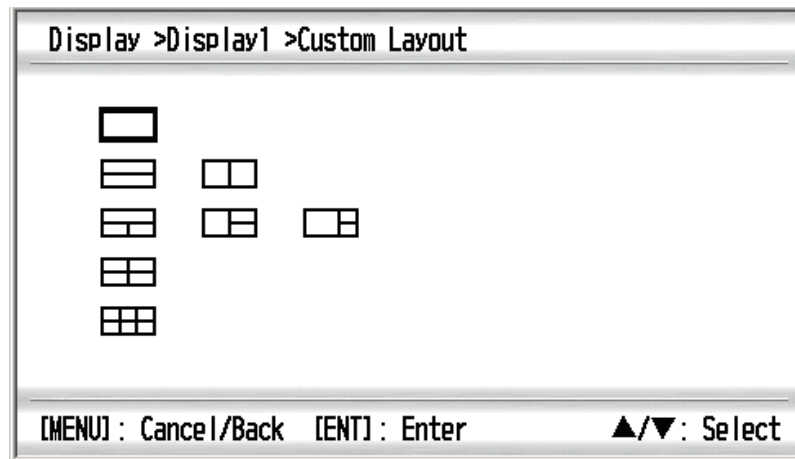



 No-split

 Horizontal two-way split

 Vertical two-way split

 Horizontal/vertical three-way split 1

 Horizontal/vertical three-way split 2

 Horizontal/vertical three-way split 3

 Four-way split

 Six-way split

3. CUSTOM SCREEN

- Use the Cursorpad to select the screen division and press the **ENT** key. The option screen depends on the selected screen division.

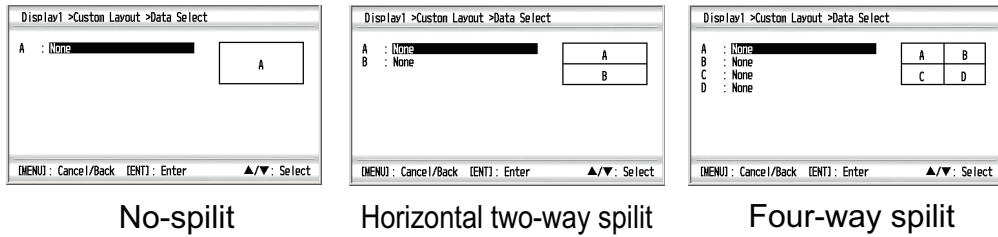

Examples of option screen

- Press the **ENT** key again with the cursor on [A].

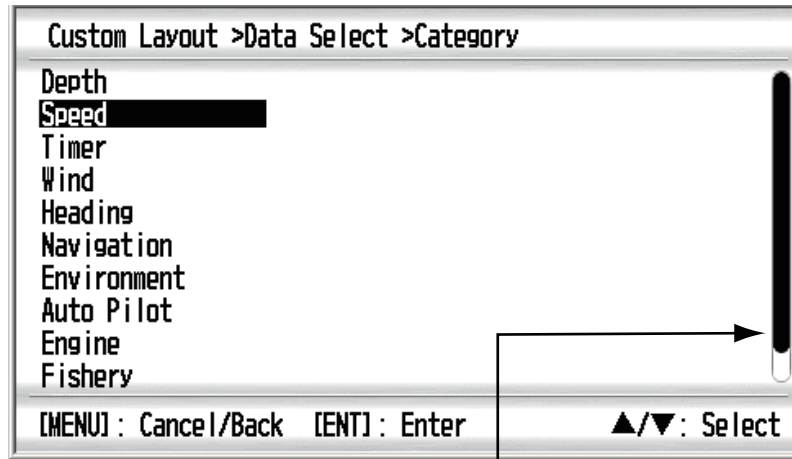

Scroll bar

- Use the Cursorpad (▲ or ▼) to select the category desired and press the **ENT** key. The scroll bar indicates additional categories. You can scroll through the categories by using the Cursorpad (▲ or ▼). The category options screen, which depends on the selected category, appears.

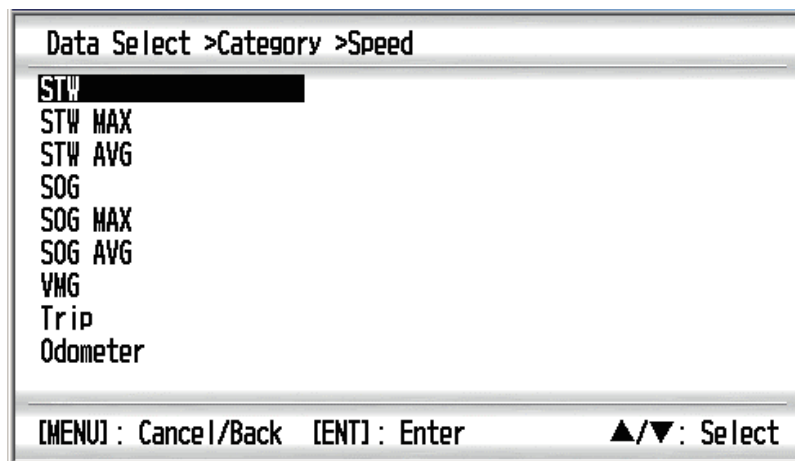

Category options (e.g. [Speed] category)

Note 1: If you selected [None], the data screen is blank.

Note 2: For details for each category, see the next section.

8. Use the Cursorpad (▲ or ▼) to select an option desired and press the **ENT** key.

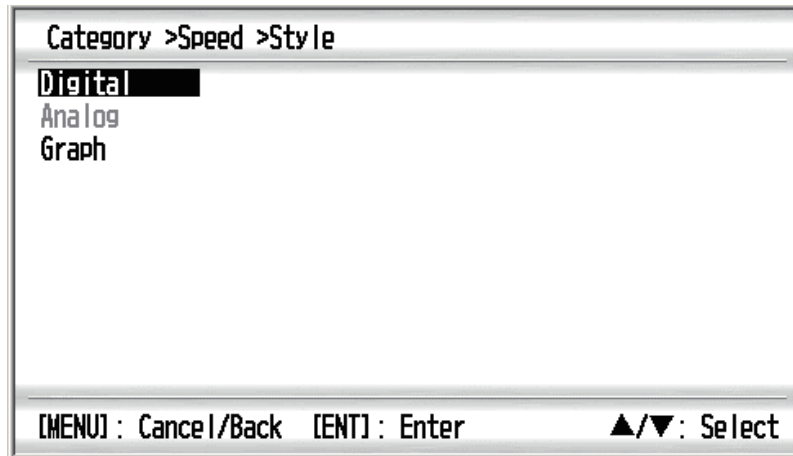

Style options (e.g. [Speed] category)

Note: The menu items in gray are not available.

9. Use the Cursorpad (▲ or ▼) to select [Digital], [Analog] or [Graph] then press the **ENT** key. If you selected the no-split screen at step 5, go to step 12. For the other types, go to step 10.

Note: The available style options depend on the selected screen division, category and category option. The unavailable style option is displayed in gray.

10. Use the Cursorpad (▲ or ▼) to select [B (C, D, E or F)] and press the **ENT** key.
 11. Repeat steps 7 to 10 to set the category and the style option for each split screen.
 12. Press the **DISP** key to close the menu and display the data screen.

Note: If you selected the depth graph in the split screen, the updating for the data of other data screens can slow. For example, if you selected the depth graph on [A] in horizontal/vertical three-way split 1, the updating for the data of [B] and [C] can slow.

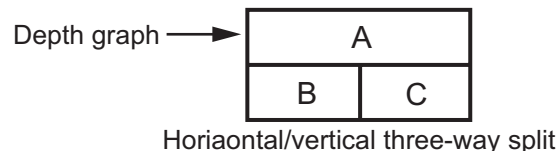

3.2 Options for Categories

See the table below for the options for each category.

Category	Option	Description	Indication
Depth	Depth	Water depth	Depth
Speed	STW	Speed Through the Water	STW
	STW MAX	Maximum STW	STW MAX
	STW AVG	Average STW	STW AVG
	SOG	Speed Over the Ground	SOG
	SOG MAX	Maximum SOG	SOG MAX
	SOG AVG	Average SOG	SOG AVG
	VMG	Velocity Made Good: Velocity component to windward	VMG
	Trip	Trip distance	Trip
	Odometer	Total trip distance	Odo, Odometer

3. CUSTOM SCREEN

Category	Option	Description	Indication
Timer (See section 3.6.)	Stopwatch	Count up timer	Stopwatch
	Timer1 (2)	Count down timer	Timer1, Timer2
Wind	Wind Speed	Apparent Wind Speed (AWS): Wind speed measured by wind transducer. True Wind Speed (TWS): Wind speed calculated as if the ship is stationary.	AWS, APP Wind SPD, TWS, True Wind SPD
	MAX TWS	Maximum True Wind Speed	MAX TWS
	Wind Angle	Apparent Wind Angle (AWA): Wind angle measured by wind transducer. True Wind Angle (TWA): Wind angle calculated as if the ship is stationary. Both AWA and TWA are with the ship's bow as the reference direction.	AWA, APP Wind Angle, TWA, True Wind Angle
	Low AWA	Low Apparent Wind Angle: Maximum angle of apparent wind at port side	Low AWA
	High AWA	High Apparent Wind Angle: Maximum angle of apparent wind at starboard side	High AWA
	Beaufort Wind	Beaufort wind speed: Wind speed according to wind force level	BFT, Beaufort Wind
	Ground Wind	Ground wind direction: Wind direction measured with true north as the reference direction. True wind subtracted ship's movement from apparent wind.	GW DIR, Ground Wind
Heading	Heading	Compass direction	HDG, Heading
	Heading AVG	Average heading	HDG AVG, Heading AVG
	Locked HDG (See section 3.7.)	Use for navigating with heading locked. Analog screen: The pointer indicates variation from the locked heading. The digital shows the locked heading or current heading. Digital screen: Display the locked heading.	Locked HDG
	Next Tack	Heading on next tack: Heading against TWA (True Wind Angle)	TACK, Next Tack
	COG	Course Over the Ground	COG
	CMG	Course Made Good: Direction from the starting point to the current point	CMG
	DMG	Distance Made Good: Distance from the starting point to the current point	DMG
	ROT	Rate Of Turn: Head angle change during one minute	ROT

Category	Option	Description	Indication
Navigation	BRG	Bearing from your ship to the destination waypoint	BRG
	Locked BRG (See section 3.7.)	Use for navigating with bearing for the destination waypoint locked. Analog screen: The pointer indicates variation from the locked bearing. The digital shows the locked bearing or current bearing. Digital screen: Display the locked bearing.	Locked BRG
	RNG	Distance from your ship to the destination waypoint	RNG
	XTE (See section 3.8.)	Analog screen: Display the highway screen with the cross-track error. Digital screen: Display the cross-track error.	XTE
	Waypoint No.	Waypoint number	WPT No. Waypoint No.
	Waypoint Name	Waypoint name	WPT Name, Waypoint Name
	Position	Position (latitude/longitude) of your ship	POSN, Position
	COG	Course Over the Ground	COG
	SOG	Speed Over the Ground	SOG
	Satellites	GPS (GNSS) satellite numbers for using position fixing	GPS SAT, Satellites
	Roll/Pitch*	Angle for right and left sway, back and forward sway of your ship	-
	Roll	Angle for right and left sway of your ship (S: Starboard upward, P: Port upward)	Roll
	Pitch	Angle for back and forward sway of your ship (+: The bow upward, -: The stern upward)	Pitch
	Destination	Destination position (latitude/longitude)	Dest, Destination
	ETA Time	Estimated Time of Arrival to destination	ETA Time
	ETA Date	Estimated date of arrival to destination	ETA Date
	TD	Position using the time difference (Loran C)	TD
Laylines*	Two lines toward the right and left with reference to the ground wind around the destination waypoint	-	

3. CUSTOM SCREEN

Category	Option	Description	Indication
Environment	Voltage	Input voltage	Volts, Voltage
	Time (See section 7.5.)	Current time	Time
	Date (See section 7.5.)	Current date	Date
	Water Temp	Water temperature	W Temp, Water Temp
	Air Temp	Air temperature	Air Temp
	Air Press	Air pressure	APress, Air Press
	Humidity	Humidity	HUMID, Humidity
	Wind Chill	Wind chill temperature	Chill, Wind Chill
	Dew Point	Dew point: Temperature at which steam starts to be waterdrop	Dew, Dew Point
Auto Pilot	Rudder Angle	Rudder angle (S: Starboard, P: Port)	Rudder, Rudder Angle
Engine	Instance (0, 1, 2, 3)	This option does not denote a specific data screen. This number indicates the engine number that appears on all engine data screens.	0, 1, 2, 3
	Fuel Info	Trip fuel used	Total, Fuel Info
	Fuel Rate	Fuel consumption per hour	Rate, Fuel Rate
	Engine RPM	Engine Revolutions Per Minute	RPM, Engine RPM
	Engine Trim	Engine trim angle	Trim, Engine Trim
	Boost	Engine boost pressure	Boost
	Engine Temp	Engine temperature	E Temp, Engine Temp
	Engine Hours	Total used hours of engine	Hours, Engine Hours
	Oil Press	Engine oil pressure	Oil P, Oil Press
	Oil Temp	Engine oil temperature	Oil, Oil Temp
	Coolant	Engine coolant pressure	Coolant
	Engine Load	Percent engine load	Load, Engine Load
Fishery	Current1 SPD	Current (tide) speed of first layer	CUR 1, Current1 SPD
	Current1 DIR	Current (tide) direction of first layer	CUR 1 DIR, Current1 DIR
	Current2 SPD	Current (tide) speed of second layer	CUR 2, Current2 SPD
	Current2 DIR	Current (tide) direction of second layer	CUR 2 DIR, Current2 DIR
	Current3 SPD	Current (tide) speed of third layer	CUR 3, Current3 SPD
	Current3 DIR	Current (tide) direction of third layer	CUR 3 DIR, Current3 DIR
None	-	Blank screen	

*: Only for no-split screen

3.3 Data Screen

The following are the examples of data screens.

No-split

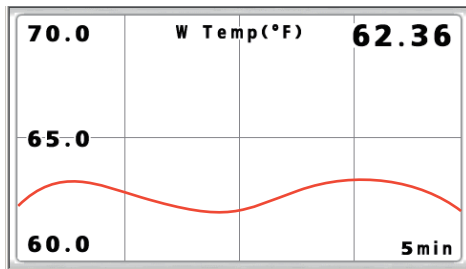

Environment - Water Temp - Graph

No-split

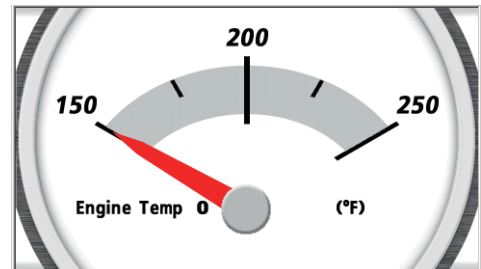

Engine - Engine Temp - Analog
(Instance (engine number): 0)

Horizontal two-way split

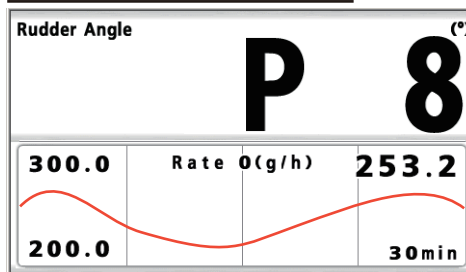

Auto Pilot - Rudder Angle - Digital
Engine - Fuel Rate - Graph

Vertical two-way split

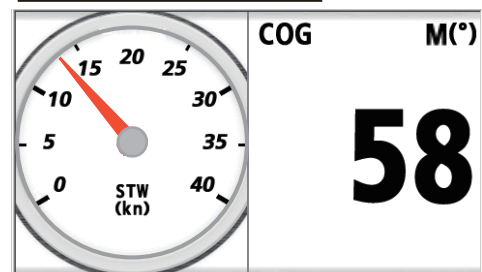

Speed - STW - Analog
Navigation - COG - Digital

Horizontal/vertical three-way split 1

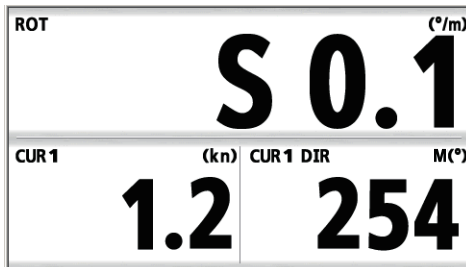

Heading - ROT - Digital
Fishery - Current1 SPD - Digital
Fishery - Current1 DIR - Digital

Horizontal/vertical three-way split 2

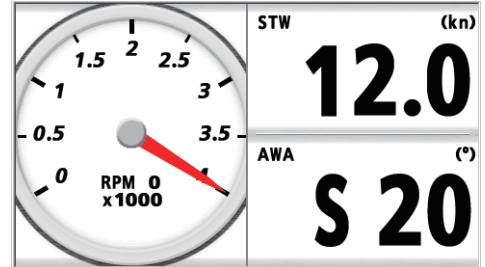

Engine - Engine RPM - Analog
Speed - STW - Digital
Wind - Wind Angle - Digital

Horizontal/vertical three-way split 3

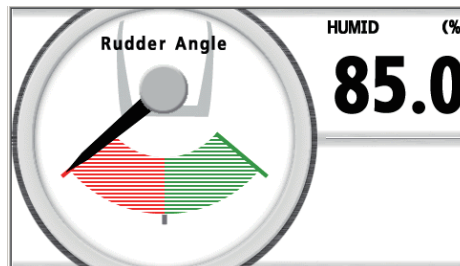

Auto Pilot - Rudder Angle - Analog
Environment - Humidity - Digital
None

Four-way split

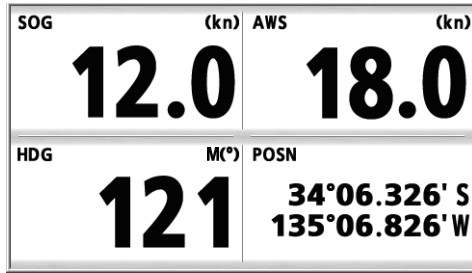

Speed - SOG - Digital
 Wind - Wind Speed - Digital
 Heading - Heading - Digital
 Navigation - Position - Digital

Six-way split

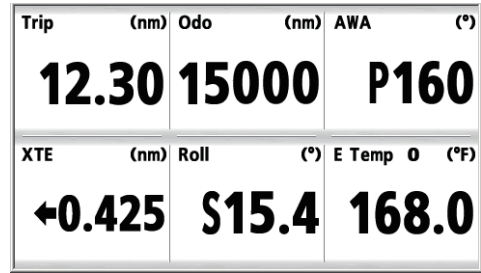

Speed - Trip - Digital
 Speed - Odometer - Digital
 Wind - Wind Angle - Digital
 Navigation - XTE - Digital
 Navigation -Roll -Digital
 Engine - Engine Temp - Digital

3.4 How to Set the Graph Display

3.4.1 How to enable auto range shift

The auto range shift feature automatically shifts the display range of a graph to display data on the graph.

Note 1: The default setting of Auto Range Shift is [On].

Note 2: Auto range shift works with water temperature, air pressure, and humidity.

1. With the data screen displayed, press the **ENT** key.

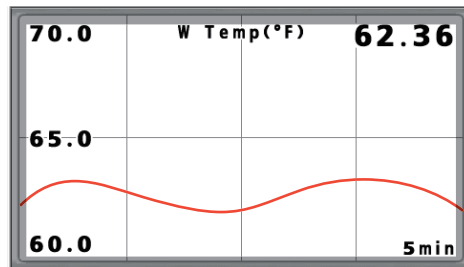

2. Long-press the **ENT** key. The properties screen, whose contents change according to input data, appears.

Water Temp		
Unit	:	°F
Offset	:	+ 0.0°F
Alarm	:	Outside +60.00°F +80.00°F
Style	:	Graph
Auto Range Shift	:	On 5°F
Scale (Start From)	:	+ 40.0°F
Scale (Max Range)	:	+ 40.1°F
Period	:	5min
[MENU]: Cancel/Back [ENT]: Enter ▲/▼: Select		

- Use the Cursorpad (▲ or ▼) to select [Auto Range Shift] and press the **ENT** key.

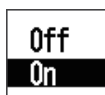

- Use the Cursorpad (▼) to select [On] and press the **ENT** key.
To disable the auto range shift, select [Off].
- Use the Cursorpad (▶) to move the cursor to the right and press the **ENT** key.

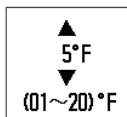

- Use the Cursorpad (▲ or ▼) to set the value and press the **ENT** key.
- Press the **DISP** key to close the menu and display the data screen.

3.4.2 How to set the period of the graph

Set the interval to display data on the graph as follows:

- With the data screen displayed, press the **ENT** key.
The data box is in selective condition.

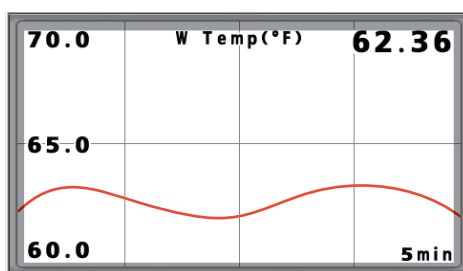

- Long-press the **ENT** key. The properties screen, whose contents change according to input data, appears.

Water Temp			
Unit	:	°F	
Offset	:	+ 0.0°F	
Alarm	:	Outside	+60.00°F
			+80.00°F
Style	:	Graph	
Auto Range Shift	:	On	5°F
Scale (Start From)	:	+ 40.0°F	
Scale (Max Range)	:	+ 40.1°F	
Period	:	5min	
[MENU] : Cancel/Back [ENT] : Enter ▲/▼ : Select			

- Use the Cursorpad (▲ or ▼) to select [Period] and press the **ENT** key.

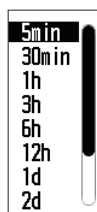

- Use the Cursorpad (▲ or ▼) to set the value and press the **ENT** key.
- Press the **DISP** key to close the menu and display the data screen.

3.5 How to Switch the Wind Mode and the Direction Mode

You can switch the wind mode and the direction mode as follows.

Wind mode

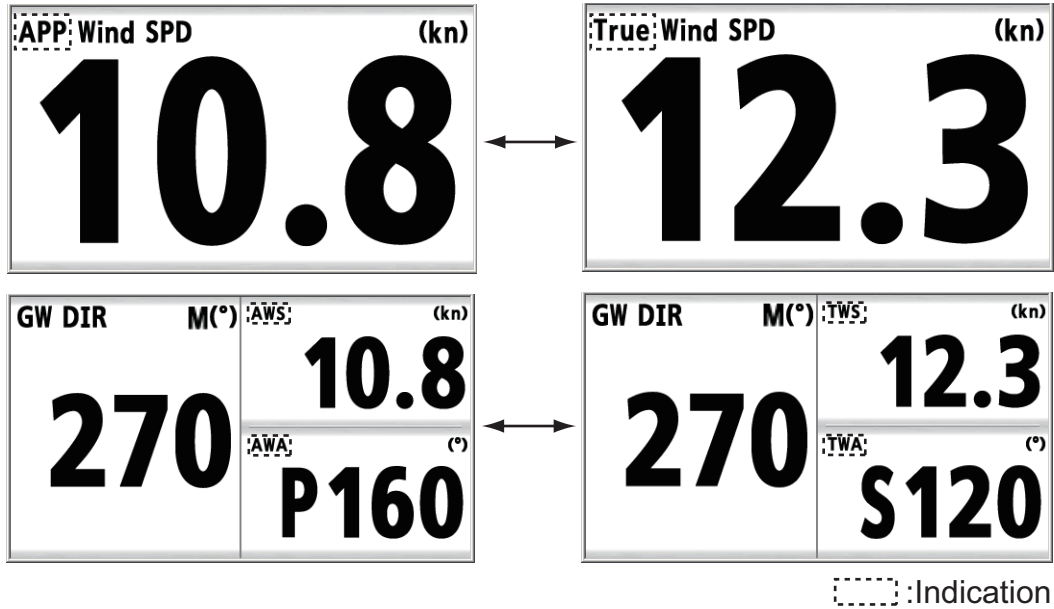

To switch the mode, press the **APP/TRUE** key.

[APP]: Apparent or relative wind. The wind direction relative to the ship's bow and the wind speed relative to the moving ship.

[True]: True or calculated wind. The wind direction relative to the ship's bow and the wind speed as if the ship is stationary.

[AWS]: Apparent Wind Speed. Wind speed measured by wind transducer.

[TWS]: True Wind Speed. Wind speed calculated as if the ship is stationary.

[AWA]: Apparent Wind Angle. Wind angle measured by wind transducer.

[TWA]: True Wind Angle. Wind angle calculated as if the ship is stationary.

Direction mode

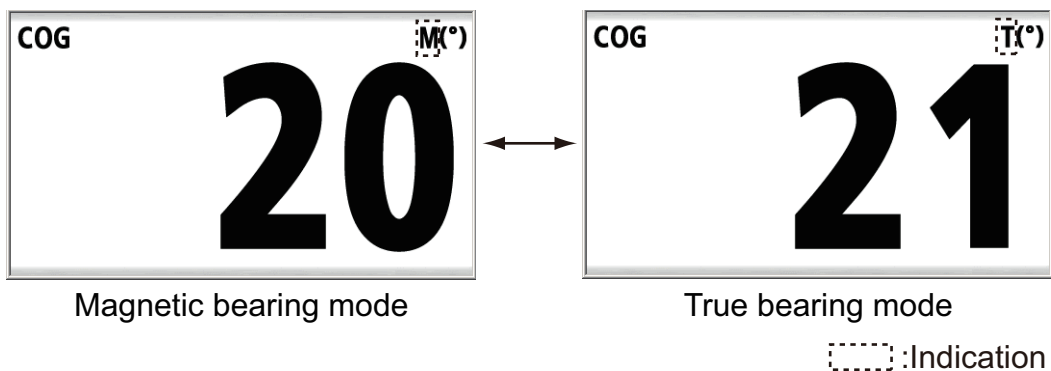

E.g. [Heading] - [COG] screens

1. With the data screen displayed, press the **ENT** key.



2. Press the **ENT** key long. The properties screen, which depends on the selected data screen, appears.

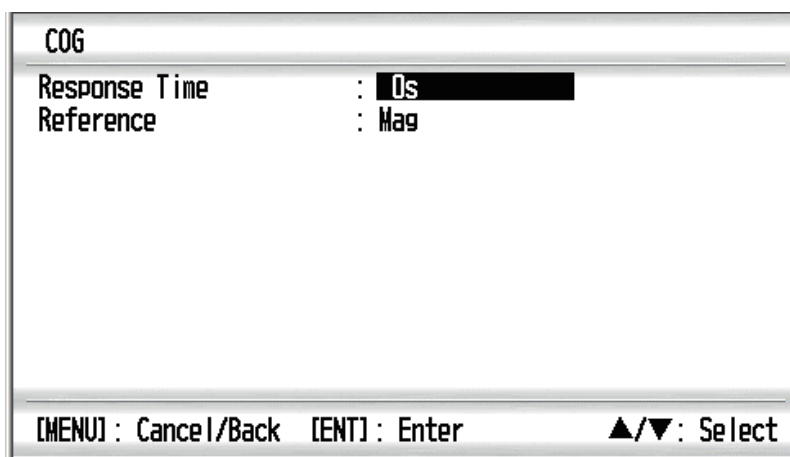

3. Use the Cursorpad (▲ or ▼) to select [Reference] and press the **ENT** key.



4. Use the Cursorpad (▲ or ▼) to select [True] or [Mag] then press the **ENT** key.
[True]: The bearing measured using true North as the reference direction.
[Mag]: Magnetic; The bearing measured with magnetic north as the reference direction.
5. Press the **DISP** key to close the menu and display the data screen.

3.6 Stopwatch and Timer

You can display the stopwatch or timer screen for no-split screen or horizontal/vertical three-way split 3 screen (☐☐) (see sections 3.1 and 3.2).

[Stopwatch]: Count up timer

[Timer1 (2)]: Count down timer

Stopwatch

To start the timer, press the **START/CLEAR** key. To lap or stop the timer, press the **START/CLEAR** key. Though the time indication stops, the count is continued internally. To start the timer again, press the **START/CLEAR** key again.

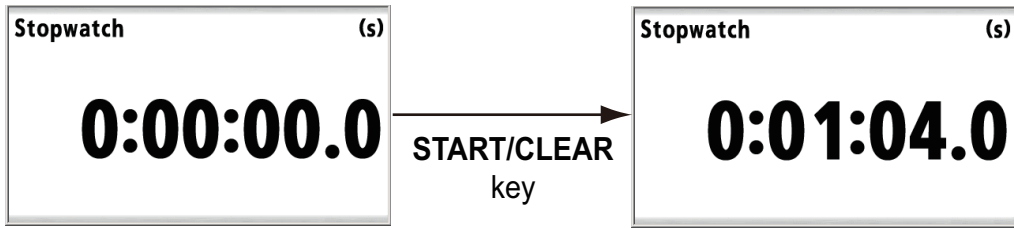

[Stopwatch]: Count up timer

Timer1 (2)

Set the time with the Cursorpad (▼) (default is 15:00.0 (maximum)). To start the timer, press the **START/CLEAR** key. To lap or stop the timer, press the **START/CLEAR** key. Though the time indication stops, the count is continued internally. To start the timer again, press the **START/CLEAR** key again. When the remaining time is 10 minutes, the alarm sounds. Then the alarm sounds at the specified time. When the count is 0, the timer counts up the time.

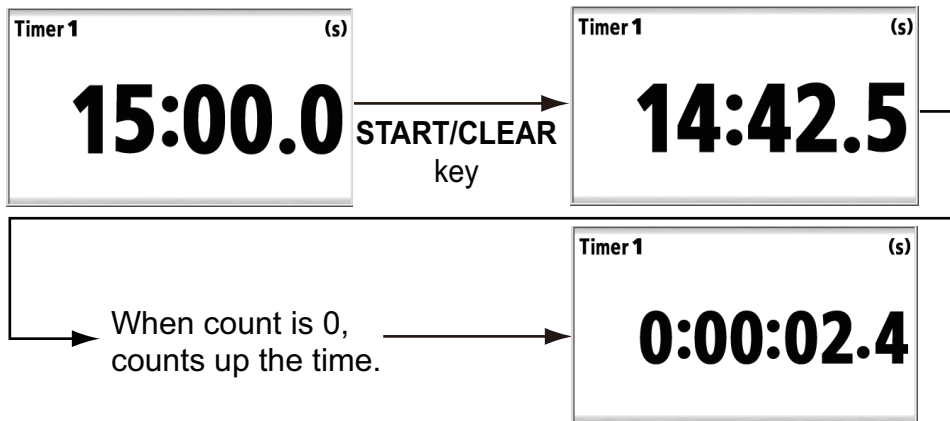

[Timer1 (2)]: Count down timer

How to reset the value

For no-split screen: Press the **START/CLEAR** key long.

For horizontal/vertical three-way split 3 screen: Press the **ENT** key to select the screen for [Stopwatch] or [Timer1 (2)] and press the **START/CLEAR** key long.

After you press the **START/CLEAR** key long, one long beep sounds.

3.7 Locked HDG/BRG

Analog screen

Lock the heading or bearing at desired angle and display the variation from the locked heading or bearing in the analog meter. This function is available for no-split screen and horizontal/vertical three-way split 3 (□□) screen. To display the locked heading or locked bearing screen, select [Locked HDG] or [Locked BRG] on the [Heading] or [Navigation] category (see sections 3.1 and 3.2).

Press the **START/CLEAR** key to lock the heading or bearing. The pointer shows the variation of the ship's heading or bearing. To unlock the heading or bearing, press the **START/CLEAR** key.

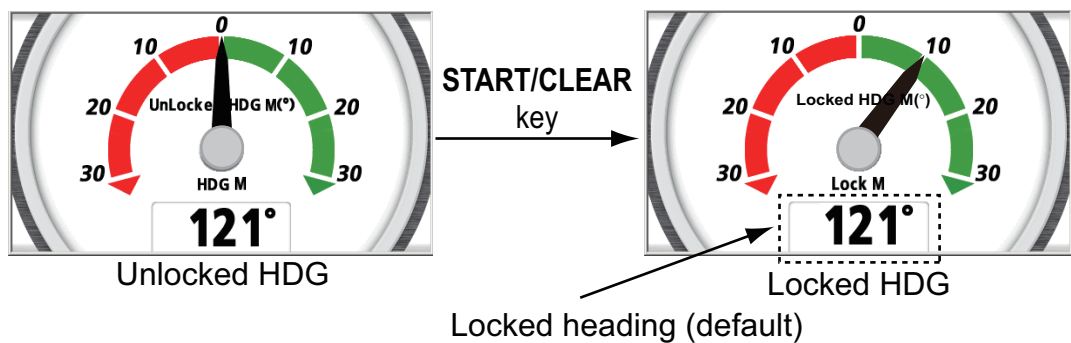

E.g. [Locked HDG] - [Analog]

Note: The digital angle indication is not displayed on the horizontal/vertical three-way split 3 screen.

The digital locked heading/bearing is the angle at the moment that the **START/CLEAR** key is pressed. The pointer shows the difference between the locked heading/bearing and the actual course.

To display the current heading or bearing at the bottom of the [Locked HDG] or [Locked BRG] screen, do the following:

1. With the [Locked HDG] or [Locked BRG] screen displayed, press the **ENT** key.
2. Press the **ENT** key long.

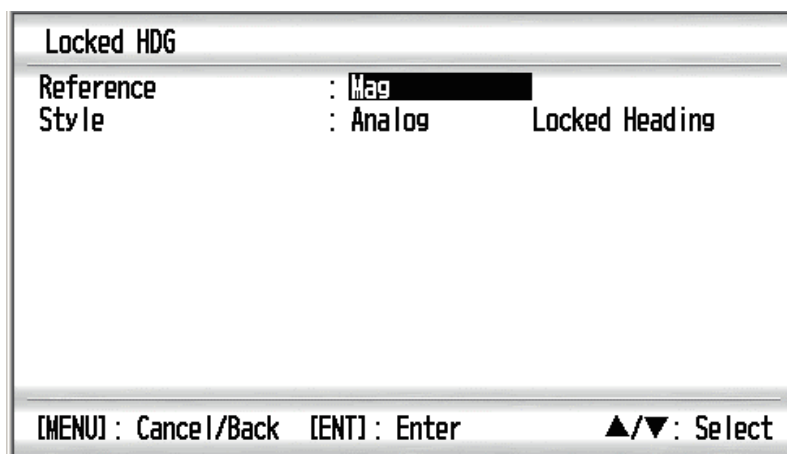

E.g. [Locked HDG]

3. CUSTOM SCREEN

3. Use the Cursorpad (▲ or ▼) to select [Style] and use the Cursorpad (▶) to move the cursor to the right.
4. Press the **ENT** key.



E.g. [Locked HDG]

5. Use the Cursorpad (▲ or ▼) to select [Current Heading] or [Current Bearing] then press the **ENT** key.
6. Press the **DISP** key to close the menu and display the data screen.

Note 1: See section 3.5 for instructions on changing the direction mode.

Note 2: You can perform this operation in the [System] menu (see section 7.6).

Digital screen

To display only the value for the locked heading or the locked bearing in zoomed format, change the analog format to digital format.

1. With the [Locked HDG] or [Locked BRG] screen displayed, press the **ENT** key.
2. Press the **ENT** key long.
3. Use the Cursorpad (▲ or ▼) to select [Style] and press the **ENT** key.
4. Use the Cursorpad (▲ or ▼) to select [Digital] and press the **ENT** key.
5. Press the **DISP** key to close the menu and display the data screen.



E.g. [Locked HDG] - [Digital]

3.8 Cross-Track Error

The cross-track error is displayed in the highway screen in analog format. The highway screen provides a graphic presentation of ship's progress toward a destination waypoint, with range and bearing to the destination waypoint, ship's course and speed, and the ship's position. Select [XTE] on the [Navigation] category (see sections 3.1 and 3.2).

Analog screen

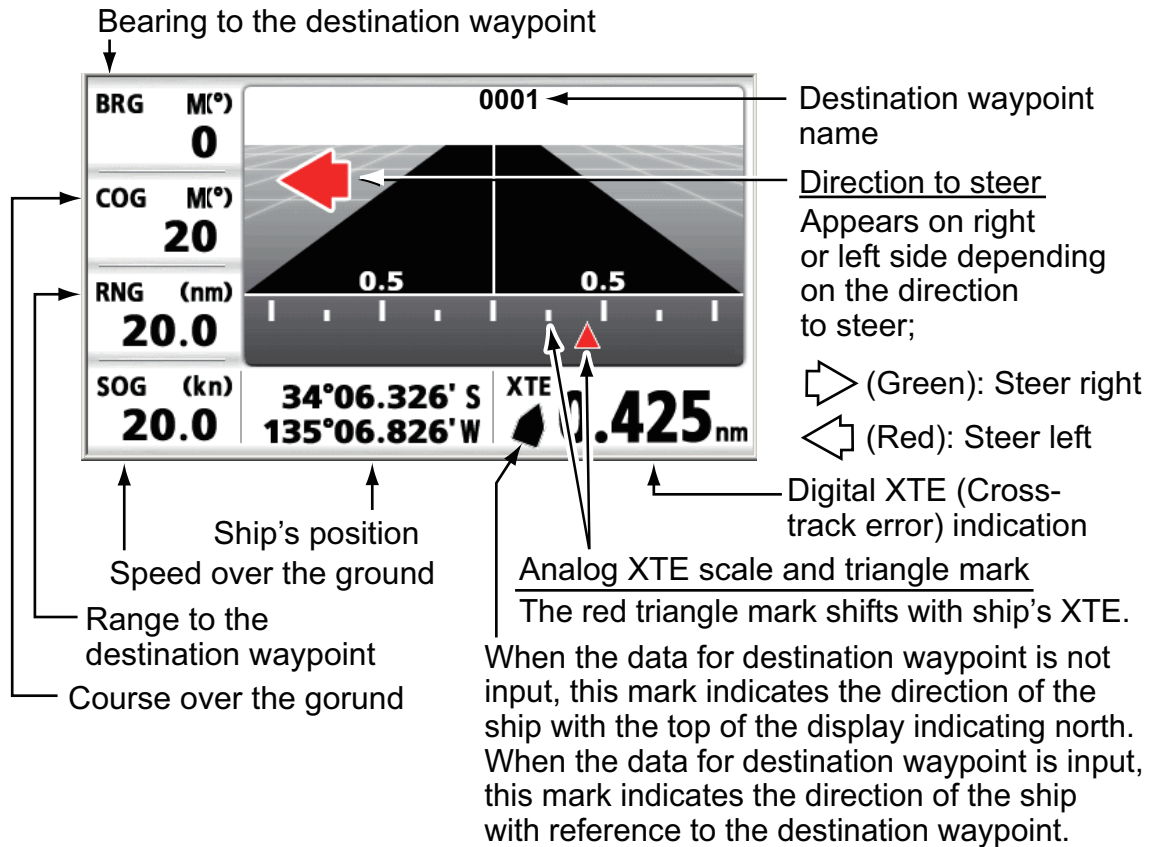

[XTE] - [Analog]

Digital screen

To display only the digital XTE, select [Digital] on the style option.



[XTE] - [Digital]

3. CUSTOM SCREEN

How to change the unit

You can select the XTE unit from nm, km or sm as follows:

1. With the data screen for XTE displayed, press the **ENT** key.
2. Press the **ENT** key long.

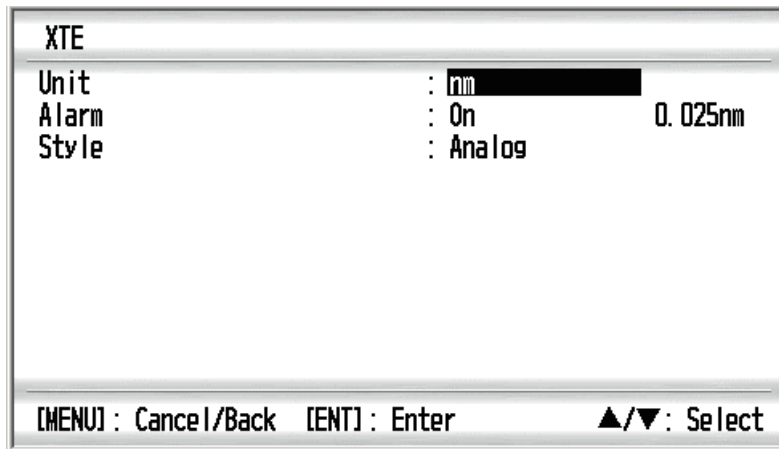

3. Use the Cursorpad (▲ or ▼) to select [Unit] and press the **ENT** key.
4. Use the Cursorpad (▲ or ▼) to select [nm], [km] or [sm] then press the **ENT** key.
5. Press the **DISP** key to close the menu and display the data screen.

How to change the scale range

You can change the scale range for analog XTE. With the data screen for XTE displayed, use the Cursorpad to change the scale range.

▲, ►: Increase the numeric value.

▼, ◀: Decrease the numeric value.

Unit	Scale range
nm	0.2, 0.4, 0.8, 1.0, 2.0, 4.0, 8.0, 16.0
km	0.2, 0.4, 1.0, 2.0, 4.0, 10.0, 20.0, 30.0
sm	0.2, 0.4, 0.8, 1.0, 2.0, 4.0, 8.0, 16.0

Note: When the XTE exceeds the setting scale range, the red triangle mark on the highway screen flashes.

3.9 How to Switch the Digital Data for Heading and Wind Angle

You can switch the digital data on the analog screen as follows.

Heading (Available for , , ,)

Use the Cursorpad (▶) to switch the digital data for heading. The digital data changes as follows. The data changes in reverse order with the Cursorpad (◀).

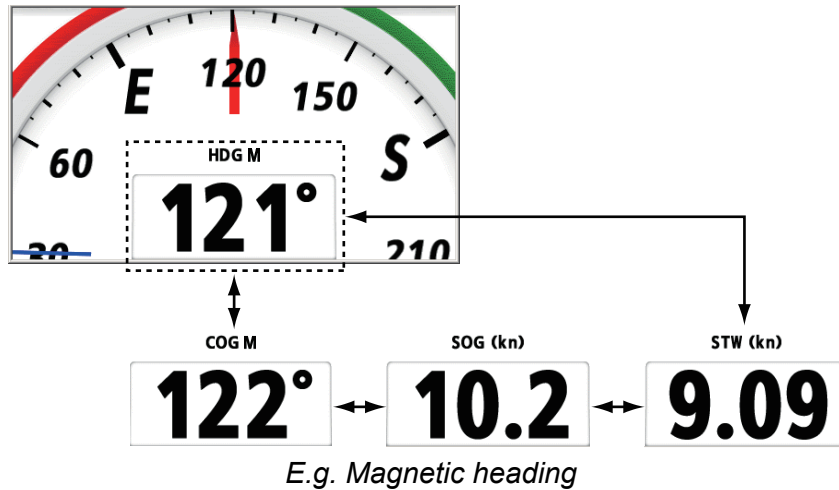

Wind Angle (Available for)

Use the Cursorpad (▶) to switch the digital data for wind angle. The digital data changes as follows. The data changes in reverse order with the Cursorpad (◀).

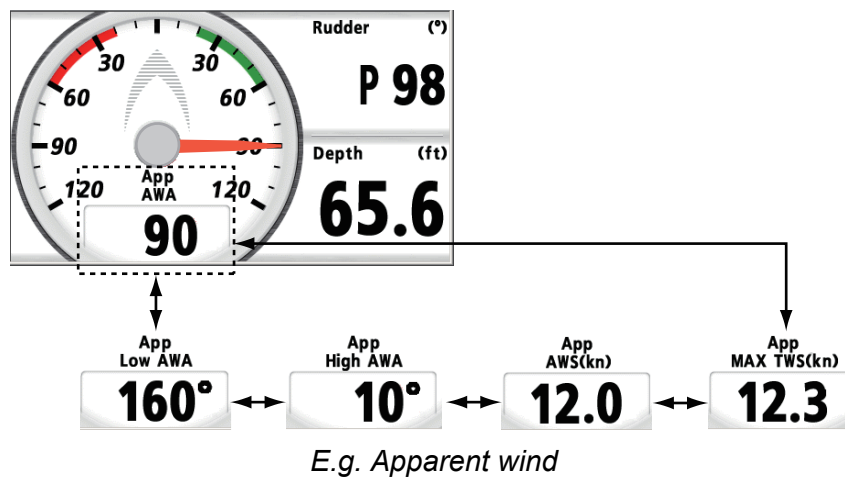

3.10 How to Reset the Value

You can reset the value for the following options by pressing the **START/CLEAR** key long.

Category	Option
Speed	STW MAX, STW AVG, SOG MAX, SOG AVG, Trip* ¹
Timer	Stopwatch, Timer1, Timer2
Wind	MAX TWS, Low AWA, High AWA
Heading	Heading AVG, CMG* ² , DMG* ²

*1: When [Trip · ODO] in the [System] menu is set to [External], trip for the sensor is reset. The sensor must output PGN 126208 (Acknowledge Group Function) in order to reset trip.

*2: Both are reset simultaneously.

When the value which you want to reset is displayed in the data screen, long press the **START/CLEAR** key. The value is reset after the one long beep.

Note: In the split screen, press the **ENT** key to activate the data box, then long press the **START/CLEAR** key.

3.11 Engine, Battery Status Icons

When the screen division is horizontal/vertical three-way split 3 (see step 4 on page 3-1), engine, battery status icons appear at the four corners of the analog meter (only when receiving PGN127489). An icon is gray when the corresponding item is normal; red when abnormal.

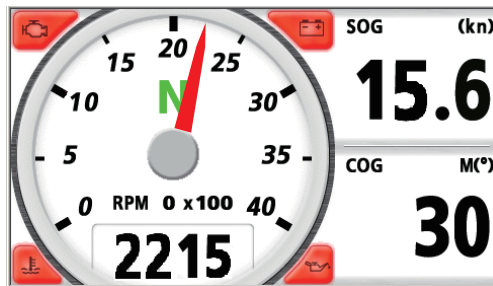

Abnormal (alarm icons light in red)

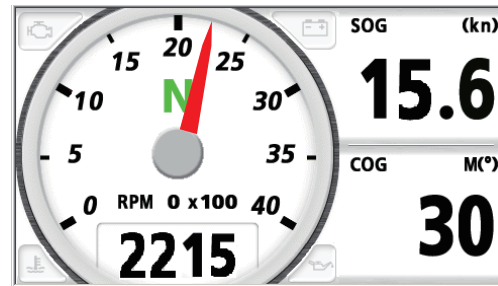

Normal

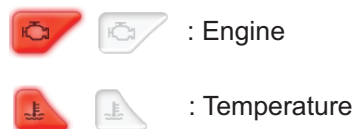

4. ALARMS

4.1 Overview

The RD-33 has 17 types of alarms as follows:

- Arrival/Anchor
- STW
- Depth Time Out
- Odometer
- Low Battery
- High APP Wind Angle
- XTE
- Water Temperature
- Time
- Roll
- Max True Wind Speed
- Low APP Wind Angle
- SOG
- Depth
- Trip
- Pitch
- Low True Wind Speed

When the alarm activates, the audio alarm sounds and the alarm message appears. The alarm icon flashes at the upper-right corner of the screen.

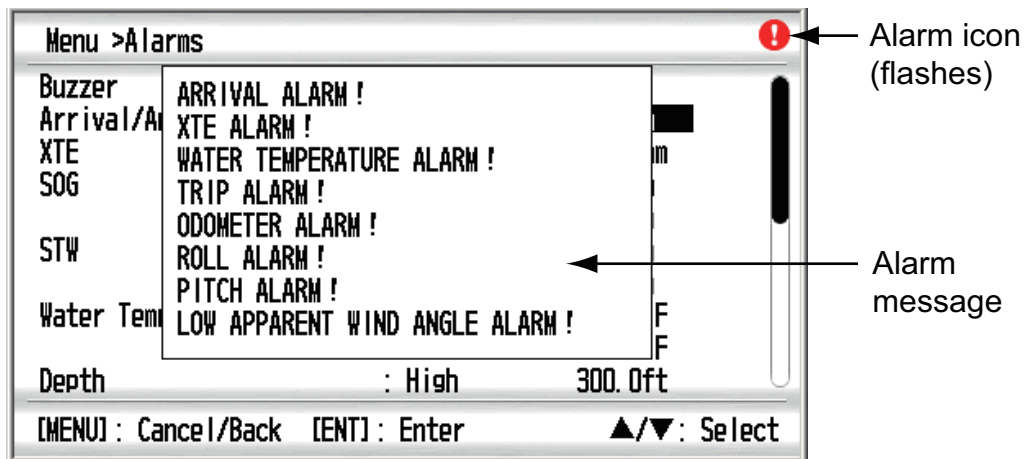

How to stop the audio alarm

When the audio alarm sounds, press any key to stop the audio alarm. The alarm message disappears. The alarm icon continuously flashes until the alarm status is cleared. When a new alarm occurs, the audio alarm sounds and the alarm message appears.

Alarm status

The alarm status window shows all currently violated alarms (max. ten). The list is updated. The alarm which is cleared from the alarm status is deleted from the list at the time. When there are no alarms, "No Message!" appears.

1. Press the **MENU** key to open the menu.

4. ALARMS

- Use the Cursorpad (▲ or ▼) to select [Messages] and press the **ENT** key. All alarms currently violated are displayed.

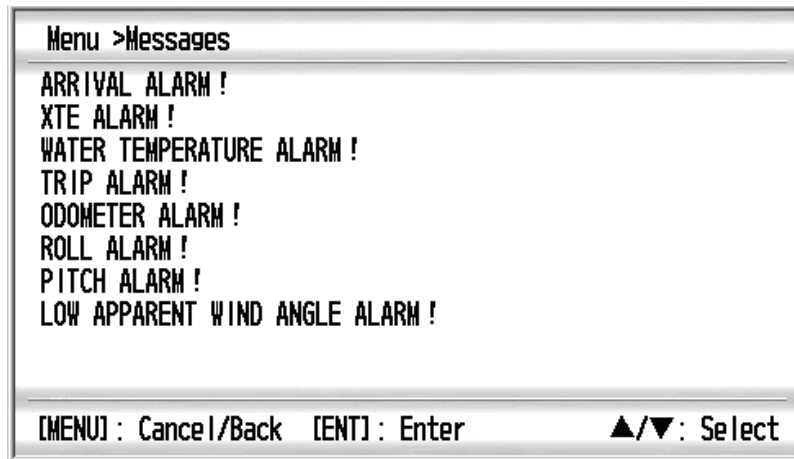

- Press the **DISP** key to close the menu and display the data screen.

Alarm category

The alarm categories displayed on the alarm status are follows:

Alarm category	Meaning	Reference
ARRIVAL ALARM!	Your ship enters the alarm zone centering on the destination waypoint.	4.3.1
ANCHOR WATCH ALARM!	Your ship is moving when your ship should be at rest.	
Anchor alarm cannot be used!	The position data is lost when the anchor alarm is on.	
XTE ALARM!	Your ship is off its intended course.	4.3.2
SOG ALARM!	The SOG alarm is generated in one of the following conditions: <ul style="list-style-type: none"> • Lower or higher than the SOG setting. • Inside or outside of the SOG range setting. • Equal to the SOG setting. 	4.3.3
STW ALARM!	The STW alarm is generated in one of the following conditions: <ul style="list-style-type: none"> • Lower or higher than the STW setting. • Inside or outside of the STW range setting. • Equal to the STW setting. 	
WATER TEMPERATURE ALARM!	The water temperature alarm is generated in one of the following conditions: <ul style="list-style-type: none"> • Lower or higher than the temperature setting. • Inside or outside of the temperature range setting. • Equal to the temperature setting. • Vary more than the temperature setting within one minute (shear). 	4.3.4
DEPTH ALARM!	The depth alarm is generated in one of the following conditions: <ul style="list-style-type: none"> • Lower or higher than the depth setting. • Inside or outside of the depth range setting. • Equal to the depth setting. 	4.3.5
DEPTH TIME OUT ALARM!	No depth data.	4.3.6

Alarm category	Meaning	Reference
TIME ALARM!	The preset time arrives.	4.3.9
TRIP ALARM!	Your ship has traveled the trip distance setting or above.	4.3.7
ODOMETER ALARM!	Your ship has traveled the odometer distance setting or above.	
ROLL ALARM!	The right and left sway of your ship is equal to or exceeds the roll setting.	4.3.8
PITCH ALARM!	The backward and forward sway of your ship is equal to or exceeds the pitch setting.	
BATTERY ALARM!	The input voltage is the voltage setting or below.	4.3.9
MAX TRUE WIND SPEED ALARM!	The true wind speed is the max true wind setting or above.	
LOW TRUE WIND SPEED ALARM!	The true wind speed is the low true wind setting or below.	
HIGH APPARENT WIND ANGLE ALARM!	The wind angle from starboard is the high apparent wind angle setting or above.	
LOW APPARENT WIND ANGLE ALARM!	The wind angle from port is the low apparent wind angle setting or above.	
RAM ERROR!	RAM storage medium is error.	8.2
ROM ERROR!	ROM storage medium is error.	

How to open the [Alarms] menu

Open the [Alarms] menu as follows:

1. Press the **MENU** key to open the menu.
2. Use the Cursorpad (▲ or ▼) to select [Alarms] and press the **ENT** key.

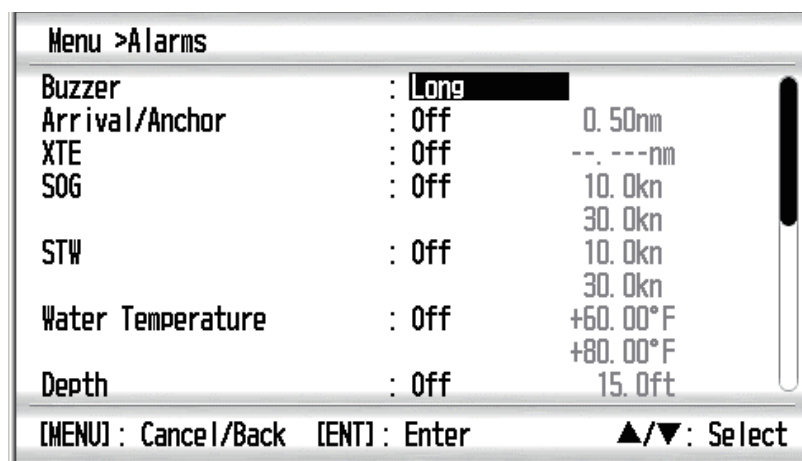

4.2 Audio Alarm Type

You can select the audio alarm type as follows:

1. Open the [Alarms] menu.
2. Use the Cursorpad (▲ or ▼) to select [Buzzer] and press the **ENT** key.



3. Use the Cursorpad (▲ or ▼) to select [Short], [Long] or [Continuous] then press the **ENT** key.

[Short]: One short beep

[Long]: Three long beeps

[Continuous]: Continuous long beeps until you press any key to acknowledge the alarm

4. Press the **DISP** key to close the menu and display the data screen.

4.3 How to Set the Alarms

4.3.1 Arrival/Anchor alarm

The arrival alarm and anchor alarm cannot be activated together.

[Arrival]: The arrival alarm alerts you that your ship enters the alarm zone centering on the destination waypoint.

[Anchor]: The anchor alarm alerts you that your ship is moving when your ship should be at rest.

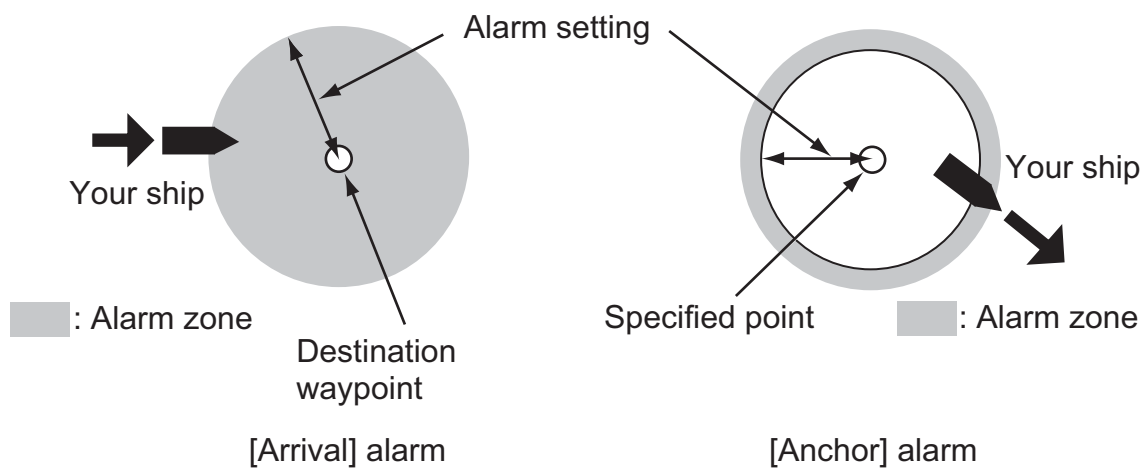

1. Open the [Alarms] menu.
2. Use the Cursorpad (▲ or ▼) to select [Arrival/Anchor] and press the **ENT** key.



3. Use the Cursorpad (▲ or ▼) to select [Arrival] or [Anchor] then press the **ENT** key. When you do not set the arrival/anchor alarm, select [Off] and go to step 6.

- Use the Cursorpad (▶) to move the cursor to the right and press the **ENT** key.



- Use the Cursorpad to set the value and press the **ENT** key. The circle with radius setting value is alarm zone.
 ▲, ▼: Change the figure.
 ◀, ▶: Move the cursor for digit.
- Press the **DISP** key to close the menu and display the data screen.

Note: The anchor alarm cannot be activated when there is no position data. If the position data is lost when the anchor alarm is on, an alarm occurs.

4.3.2 XTE (Cross-Track Error) alarm

The XTE alarm alerts you when your ship is off its intended course (the line from the start point to the destination waypoint). This function is available when the start point and the destination waypoint are set on the navigation equipment connected.

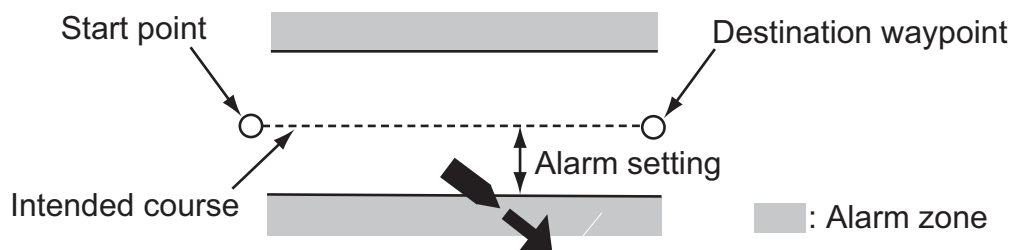

- Open the [Alarms] menu.
- Use the Cursorpad (▲ or ▼) to select [XTE] and press the **ENT** key.

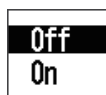

- Use the Cursorpad (▲ or ▼) to select [On] and press the **ENT** key. When you do not set the XTE alarm, select [Off] and go to step 6.
- Use the Cursorpad (▶) to move the cursor to the right and press the **ENT** key.

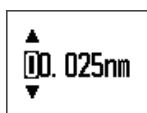

- Use the Cursorpad to set the value and press the **ENT** key.
- Press the **DISP** key to close the menu and display the data screen.

4.3.3 Speed (SOG/STW) alarm

The speed (SOG/STW) alarm alerts you when your ship's speed is lower or higher than the speed setting, is inside or outside of the speed range setting, or is equal to the speed setting.

- Open the [Alarms] menu.

4. ALARMS

- Use the Cursorpad (▲ or ▼) to select [SOG] or [STW] then press the **ENT** key.

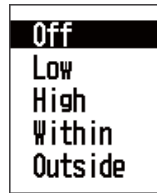

- Use the Cursorpad (▲ or ▼) to select [Low], [High], [Within] or [Outside] then press the **ENT** key. When you do not set the SOG/STW alarm, select [Off] and go to step 6.

[Low]: Alarm occurs when your ship's speed is equal to or lower than the speed setting.

[High]: Alarm occurs when your ship's speed is equal to or higher than the speed setting.

[Within]: Alarm occurs when your ship's speed is equal to or within the speed range setting.

[Outside]: Alarm occurs when your ship's speed is equal to or outside the speed range setting.

- Use the Cursorpad (▶) to move the cursor to the right and press the **ENT** key.



- Use the Cursorpad to set the value and press the **ENT** key. If you selected [Within] or [Outside] at step 3, set the value for maximum and minimum speed.

Menu > Alarms		
Buzzer	: Long	
Arrival/Anchor	: Arrival	0.50nm
XTE	: On	0.025nm
SOG	: Within	30.0kn
		40.0kn
STW	: Outside	10.0kn
		30.0kn
Water Temperature	: Outside	+60.00°F
		+80.00°F
Depth	: High	300.0ft
[MENU] : Cancel/Back [ENT] : Enter ▲/▼ : Select		

Minimum speed for SOG

Maximum speed for SOG

Minimum speed for STW

Maximum speed for STW

To move the cursor from minimum item to maximum item, use the Cursorpad (▼).

- Press the **DISP** key to close the menu and display the data screen.

4.3.4 Water temperature alarm

The water temperature alarm alerts you when the water temperature is lower or higher than the temperature setting, is inside or outside of the temperature range setting, is equal to the temperature setting, or the water temperature varies more than the temperature setting within one minute (shear).

- Open the [Alarms] menu.

- Use the Cursorpad (▲ or ▼) to select [Water Temperature] and press the **ENT** key.

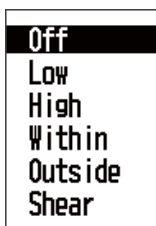

- Use the Cursorpad (▲ or ▼) to select [Low], [High], [Within], [Outside] or [Shear] then press the **ENT** key. When you do not set the water temperature alarm, select [Off] and go to step 6.

[Low]: Alarm occurs when the water temperature is equal to or lower than the temperature setting.

[High]: Alarm occurs when the water temperature is equal to or higher than the temperature setting.

[Within]: Alarm occurs when the water temperature is equal to or within the temperature range setting.

[Outside]: Alarm occurs when the water temperature is equal to or outside the temperature range setting.

[Shear]: Alarm occurs when the water temperature varies more than the temperature setting within one minute.

- Use the Cursorpad (▶) to move the cursor to the right and press the **ENT** key.



- Use the Cursorpad to set the value and press the **ENT** key. If you selected [Within] or [Outside] at step 3, set the value for maximum and minimum temperature.

▲, ▼: Select [+] or [-]. Change the figure.

◀, ▶: Move the cursor for digit.

Menu >Alarms		
Buzzer	: Long	
Arrival/Anchor	: Arrival	0. 50nm
XTE	: On	0. 025nm
SOG	: Low	10. 0kn
		40. 0kn
		10. 0kn
STW	: Off	30. 0kn
Water Temperature	: Within	+60. 00°F
		+80. 00°F
Depth	: High	300. 0ft
[MENU]: Cancel/Back [ENT]: Enter ▲/▼: Select		

To move the cursor from minimum item to maximum item, use the Cursorpad (▼).

Minimum temperature

Maximum temperature

- Press the **DISP** key to close the menu and display the data screen.

4.3.5 Depth alarm

The depth alarm alerts you when the depth is lower or higher than the depth setting, is inside or outside of the depth range setting, or is equal to the depth setting.

1. Open the [Alarms] menu.
2. Use the Cursorpad (▲ or ▼) to select [Depth] and press the **ENT** key.

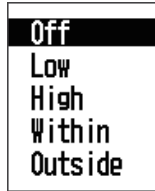

3. Use the Cursorpad (▲ or ▼) to select [Low], [High], [Within] or [Outside] then press the **ENT** key. When you do not set the depth alarm, select [Off] and go to step 6.

[Low]: Alarm occurs when the depth is equal to or shallower than the depth setting.

[High]: Alarm occurs when the depth is equal to or deeper than the depth setting.

[Within]: Alarm occurs when the depth is equal to or within the depth range setting.

[Outside]: Alarm occurs when the depth is equal to or outside the depth range setting.

4. Use the Cursorpad (▶) to move the cursor to the right and press the **ENT** key.

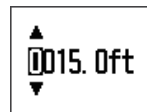

5. Use the Cursorpad to set the value and press the **ENT** key. If you selected [Within] or [Outside] at step 3, set the value for maximum and minimum depth.

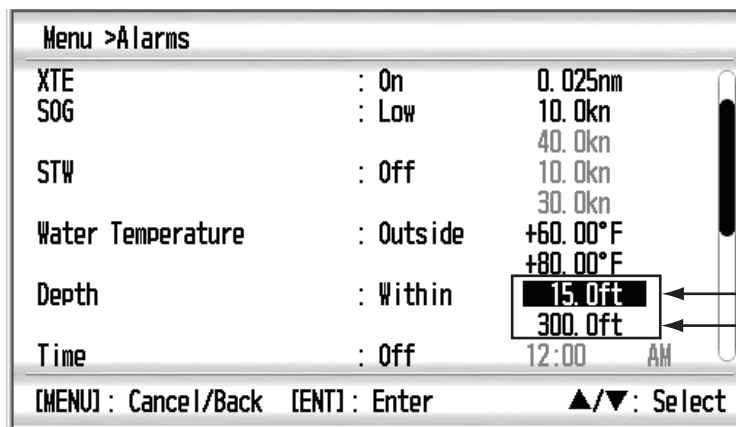

To move the cursor from minimum item to maximum item, use the Cursorpad (▼).

Minimum depth
Maximum depth

6. Press the **DISP** key to close the menu and display the data screen.

4.3.6 Depth time out alarm

The depth time out alarm alerts you when the depth data is not input for a specific time.

1. Open the [Alarms] menu.

- Use the Cursorpad (▲ or ▼) to select [Depth Time Out] and press the **ENT** key.

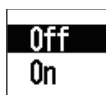

- Use the Cursorpad (▲ or ▼) to select [On] and press the **ENT** key. When you do not set the depth time out alarm, select [Off] and go to step 6.
- Use the Cursorpad (▶) to move the cursor to the right and press the **ENT** key.

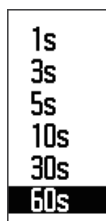

- Use the Cursorpad (▲ or ▼) to select the time and press the **ENT** key.
- Press the **DISP** key to close the menu and display the data screen.

4.3.7 Trip/odometer alarm

The trip/odometer alarm alerts you when your ship has traveled the trip/odometer distance setting or above.

- Open the [Alarms] menu.
- Use the Cursorpad (▲ or ▼) to select [Trip] or [Odometer] then press the **ENT** key.

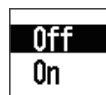

- Use the Cursorpad (▲ or ▼) to select [On] and press the **ENT** key. When you do not set the trip/odometer alarm, select [Off] and go to step 6.
- Use the Cursorpad (▶) to move the cursor to the right and press the **ENT** key.



- Use the Cursorpad to set the value and press the **ENT** key.
- Press the **DISP** key to close the menu and display the data screen.

4.3.8 Roll/pitch alarm

The roll alarm alerts you when the right and left sway of your ship is equal to or exceeds the roll setting. Set the starboard or port angle.

The pitch alarm alerts you when the backward and forward sway of your ship is equal to or exceeds the pitch setting. Set the backward or forward angle.

- Open the [Alarms] menu.
- Use the Cursorpad (▲ or ▼) to select [Roll] or [Pitch] then press the **ENT** key.

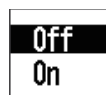

4. ALARMS

3. Use the Cursorpad (▲ or ▼) to select [On] and press the **ENT** key. When you do not set the roll/pitch alarm, select [Off] and go to step 6.
4. Use the Cursorpad (▶) to move the cursor to the right and press the **ENT** key.
5. Use the Cursorpad (▲ or ▼) to set the value and press the **ENT** key.
6. Press the **DISP** key to close the menu and display the data screen.

4.3.9 Other alarms

The following are the other alarms.

Menu item	Description	Remarks
Time	The time alarm alerts you when the preset time arrives.	Time data required.
Low Battery	The low battery alarm alerts you when the input voltage is the voltage setting or below. The setting range is 8.5 to 32.0 V.	
Max True Wind Speed	The max true wind speed alarm alerts you when the true wind speed is the max true wind setting or above.	
Low True Wind Speed	The low true wind speed alarm alerts you when the true wind speed is the low true wind setting or below.	
High APP Wind Angle	The high APP wind angle alarm alerts you when the apparent wind angle from starboard is the high apparent wind angle setting or above.	Set the starboard angle with reference to the heading.
Low APP Wind Angle	The low APP wind angle alarm alerts you when the apparent wind angle from port is the low apparent wind angle setting or above.	Set the port angle with reference to the heading.

5. INPUT/OUTPUT SETUP

The RD-33 inputs and outputs the signal in NMEA 0183 and CAN bus format. CAN bus is the network system based on NMEA 2000.

5.1 Received Data Status

You can display all data input from the sensor. See the following table about the data.

Depth	Depth
Speed	STW, SOG, Trip, Odometer
Wind	APP Wind Speed, True Wind Speed, APP Wind Angle, True Wind Angle
Heading	Heading, Variation, Deviation, COG, ROT
Navigation	BRG, RNG, XTE, Waypoint No., Waypoint Name, Lat, Lon, Satellites, Roll, Pitch, Destination Lat, Destination Lon, ETA Time, ETA Date, TD 1, TD 2
Environment	Time, Date, Water Temp, Air Temp, Air Press, Humidity
Autopilot	Rudder Angle
Engine (0) to (3)	Fuel Info, Fuel Rate, Engine RPM, Engine Trim, Boost, Engine Temp, Engine Hours, Oil Press, Oil Temp, Coolant, Engine Load
Fishery	Current1 (2 or 3) SPD, Current1 (2 or 3) DIR

1. Press the **MENU** key to open the menu.
2. Use the Cursorpad (▲ or ▼) to select [I/O Setup] and press the **ENT** key.
3. Use the Cursorpad (▲ or ▼) to select [RX Data] and press the **ENT** key.

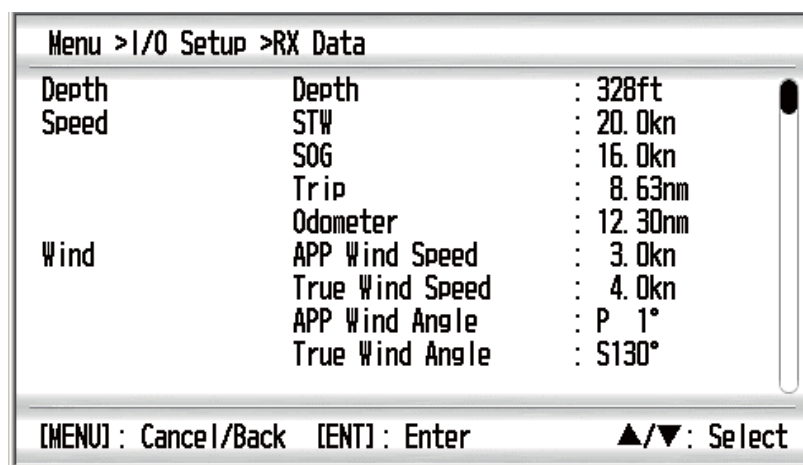

4. Use the Cursorpad (▲ or ▼) to see all data.
5. Press the **DISP** key to close the menu and display the data screen.

5.2 CAN bus Devices Status

You can display the status for up to 30 CAN bus devices connected. You can nickname each device and these nicknames are used on the [Data Source] screen (see section 5.3).

Note: The status for NMEA0183 devices is not displayed.

1. Press the **MENU** key to open the menu.
2. Use the Cursorpad (▲ or ▼) to select [I/O Setup] and press the **ENT** key.
3. Use the Cursorpad (▲ or ▼) to select [CAN bus Devices] and press the **ENT** key.

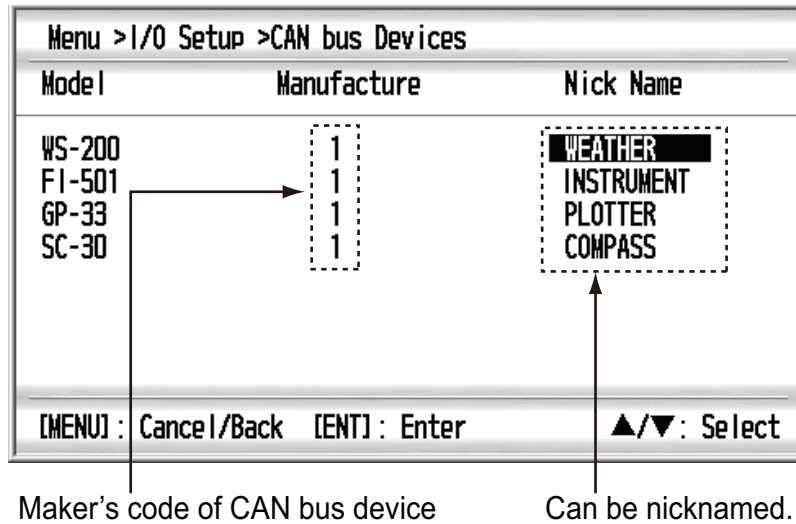

How to nickname the CAN bus device

- 1) Use the Cursorpad (▲ or ▼) to select the nickname desired and press the **ENT** key.

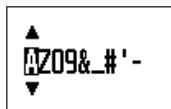

- 2) Use the Cursorpad to change the nickname. The available characters are "A to Z", "0 to 9", "&", "_", "#", "'", "-", ">" and " (space)". Set the nickname within 10 letters.
 ▲, ▼: Change the figure.
 ◀, ▶: Move the cursor for digit.
- 3) Press the **ENT** key.
4. Press the **DISP** key to close the menu and display the data screen.

5.3 Data Source

Set the data source and output the input data, in PGN format.

How to select the data source

You can select the data source to display on the screen when data of the same type is input from multiple sources. For example, you can select the position data from GPS navigation equipment or the position data from satellite compass when these two position data are input. The available data are the following:

- | | | |
|--------------------|---------------------|--------|
| • Position&SOG/COG | • Heading | • STW |
| • Depth | • Water Temperature | • Wind |
| • Date/Time | • Roll/Pitch | |

1. Press the **MENU** key to open the menu.
2. Use the Cursorpad (▲ or ▼) to select [I/O Setup] and press the **ENT** key.
3. Use the Cursorpad (▲ or ▼) to select [Data Source] and press the **ENT** key.
4. Use the Cursorpad (▲ or ▼) to select the item desired and press the **ENT** key. The list of the data source appears.

Note: NMEA0183 devices are displayed “NMEA0183” in the list of the data source.

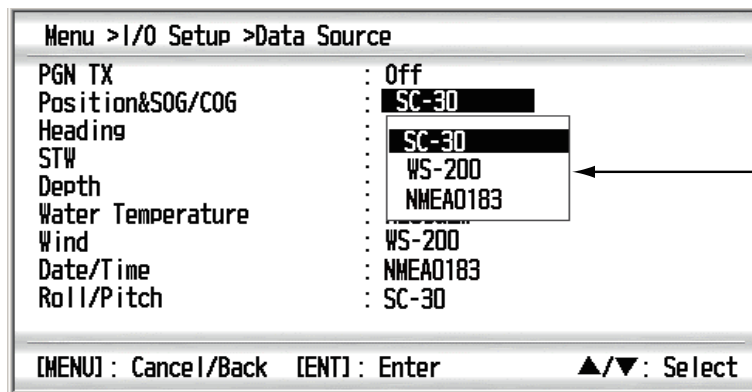

* : Except for NMEA0183 devices

5. Use the Cursorpad (▲ or ▼) to select the data source desired and press the **ENT** key.
6. Repeat steps 4 and 5 to set the other items if necessary.
7. Press the **DISP** key to close the menu and display the data screen.

How to synchronize data source

Output the input data selected as the data source, in PGN format.

1. Press the **MENU** key to open the menu.
2. Use the Cursorpad (▲ or ▼) to select [I/O Setup] and press the **ENT** key.
3. Use the Cursorpad (▲ or ▼) to select [Data Source] and press the **ENT** key.
4. Use the Cursorpad (▲ or ▼) to select [PGN TX] and press the **ENT** key.

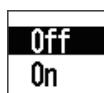

5. INPUT/OUTPUT SETUP

5. Use the Cursorpad (▲ or ▼) to select [On] and press the **ENT** key.
6. Press the **DISP** key to close the menu and display the data screen.
Note: PGN transmission by the RD-33 is turned off when an external device connected to the CAN bus network also has PGN transmission turned off.

5.4 NMEA0183 Output Mode

The [Mix] feature in the [NMEA0183 Output Mode] outputs inputted NMEA0183 format data to external equipment, in NMEA0183 format. The [NMEA2000 TRANS.] feature in the [NMEA0183 Output Mode] outputs inputted NMEA2000 format data to external equipment, in NMEA0183 format.

1. Press the **MENU** key to open the menu.
2. Use the Cursorpad (▲ or ▼) to select [I/O Setup] and press the **ENT** key.

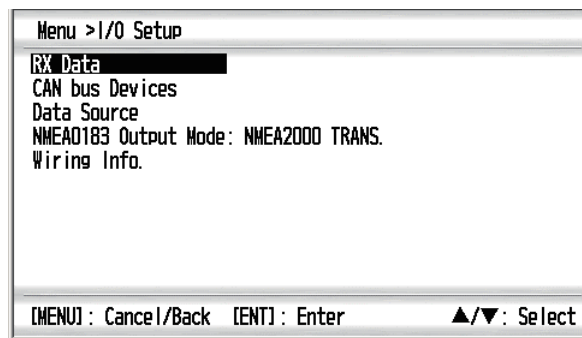

3. Use the Cursorpad (▲ or ▼) to select [NMEA0183 Output Mode] and press the **ENT** key.



4. Use the Cursorpad (▲ or ▼) to select [NMEA2000 TRANS.] or [Mix] then press the **ENT** key.
5. Press the **DISP** key to close the menu and display the data screen.

6. POSITION/TD SETUP, LAYLINES

You can display the position of your ship in latitude and longitude or Loran C TDs. Also, you can display the laylines which is the indication of navigation at yacht sailing.

6.1 Display Format for the Position of Your Ship

Set the display format for the position of your ship.

1. Press the **MENU** key to open the menu.
2. Use the Cursorpad (▲ or ▼) to select [Pos/TD Setup] and press the **ENT** key.

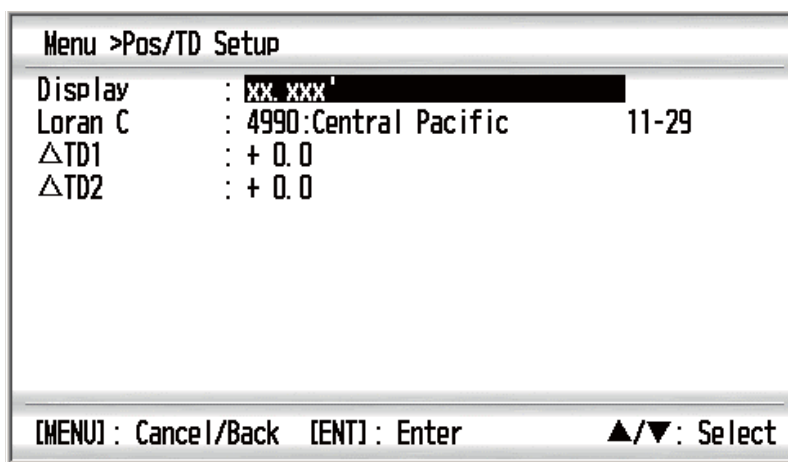

3. Use the Cursorpad (▲ or ▼) to select [Display] and press the **ENT** key.

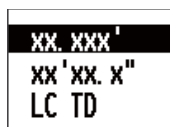

4. Use the Cursorpad (▲ or ▼) to select [xx.xxx'], [xx'xx.x''] or [LC TD] then press the **ENT** key. If you selected [xx.xxx'] or [xx'xx.x''], go to step 6.
[xx.xxx']: Display latitude and longitude with no seconds.
[xx'xx.x'']: Display latitude and longitude with seconds.
[LC TD]: Display Loran C TDs.

6. POSITION/TD SETUP, LAYLINES

5. If you selected [LC TD], do the following steps.
 - 1) Use the Cursorpad (▲ or ▼) to select [Loran C] and press the **ENT** key.

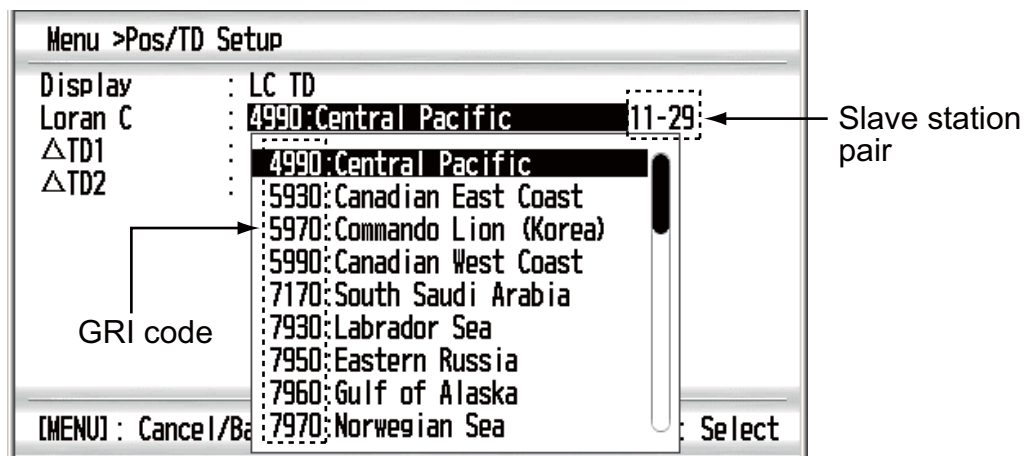

- 2) Use the Cursorpad (▲ or ▼) to select the GRI (Group Repetition Interval) code desired and press the **ENT** key.
 - 3) Use the Cursorpad (▶) to move the cursor to the slave station pair field then press the **ENT** key.
 - 4) Use the Cursorpad (▲ or ▼) to select a slave station pair then press the **ENT** key. If you know the offset, do steps 5 to 7 to display the more detailed position data.
 - 5) Use the Cursorpad (▲ or ▼) to select [△TD1] and press the **ENT** key.
 - 6) Use the Cursorpad to set the offset and press the **ENT** key.
 - 7) Repeat steps 5 and 6 to set the offset for [△TD2].
6. Press the **DISP** key to close the menu and display the data screen.

6.2 Laylines

Laylines are the two lines toward the right and left with reference to the ground wind around the destination waypoint. You can display the past lines depending on the changing laylines.

If you selected [Laylines] as the data screen, the data for VMG, SOG, RNG, BRG, TWS, AWS and Timer1 are displayed with the analog laylines data.

Note: Laylines data is not available for split screen

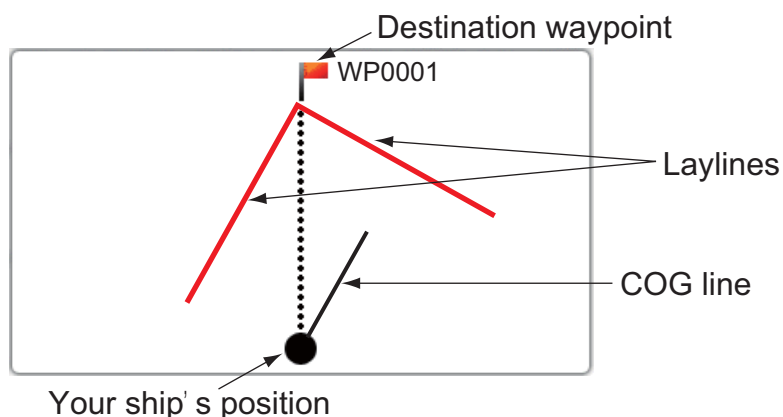

1. Press the **MENU** key to open the menu.
2. Use the Cursorpad (▲ or ▼) to select [Laylines] and press the **ENT** key.

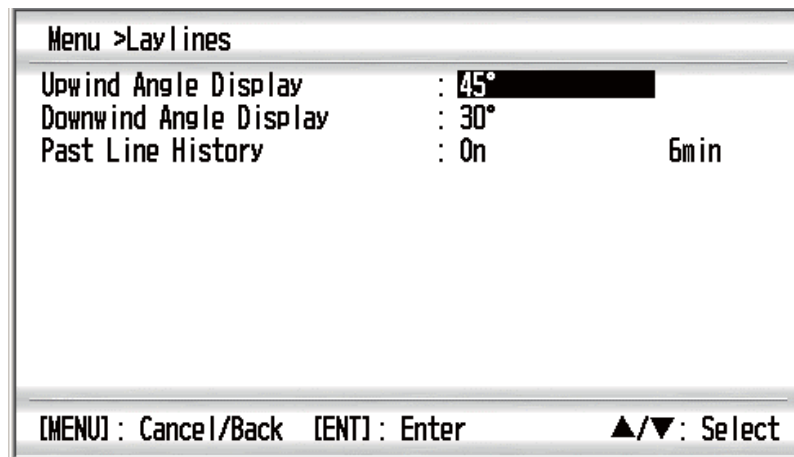

3. Use the Cursorpad (▲ or ▼) to select [Upwind Angle Display] and press the **ENT** key.

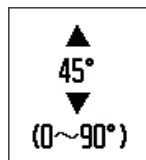

Setting window for upwind

4. Use the Cursorpad (▲ or ▼) to set the angle and press the **ENT** key.

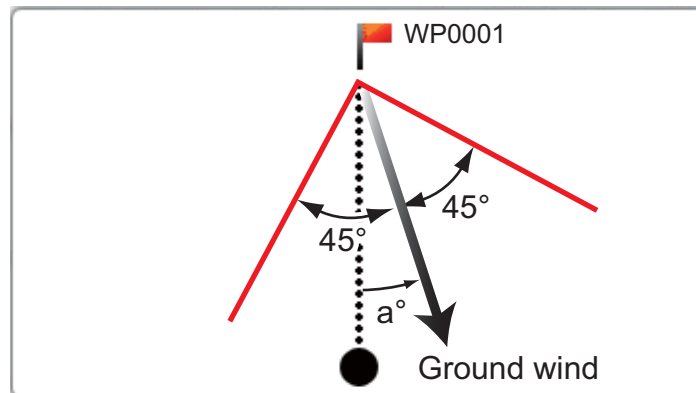

$$a^\circ = \text{Ground wind} - \text{BRG}$$

5. Repeat steps 3 and 4 to set the angle for [Downwind Angle Display].
6. Use the Cursorpad (▲ or ▼) to select [Past Line History] and press the **ENT** key.



7. Use the Cursorpad (▲ or ▼) to select [Off] or [On] then press the **ENT** key. If you selected [Off], go to step 10.
[Off]: Do not display the past laylines.
[On]: Display the past laylines.

6. POSITION/TD SETUP, LAYLINES

- Use the Cursorpad (▶) to move the cursor to the right and press the **ENT** key.

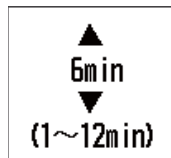

- Use the Cursorpad (▲ or ▼) to set the time interval and press the **ENT** key. You can display the five past laylines per setting time interval.
- Press the **DISP** key to close the menu and display the data screen. The past laylines are displayed in light blue.

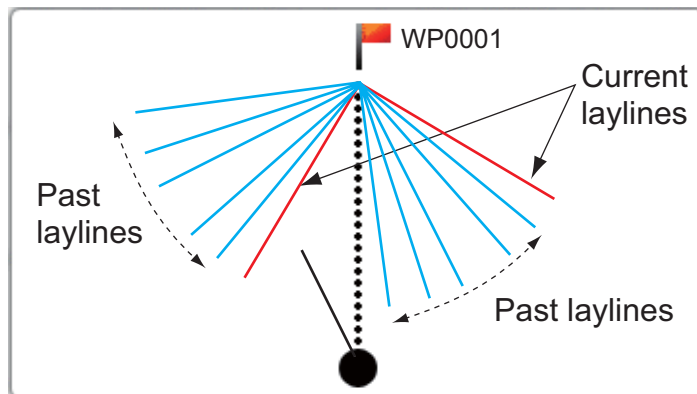

7. SYSTEM MENU

This chapter describes the [System] menu. For [Demo Mode], [Self Test] and [Factory Reset], see chapter 8.

7.1 Units of Measurement

You can set the units of measurement for depth, ship speed, distance, wind speed, water temperature, fuel and engine pressure.

1. Press the **MENU** key to open the menu.
2. Use the Cursorpad (▲ or ▼) to select [System] and press the **ENT** key.

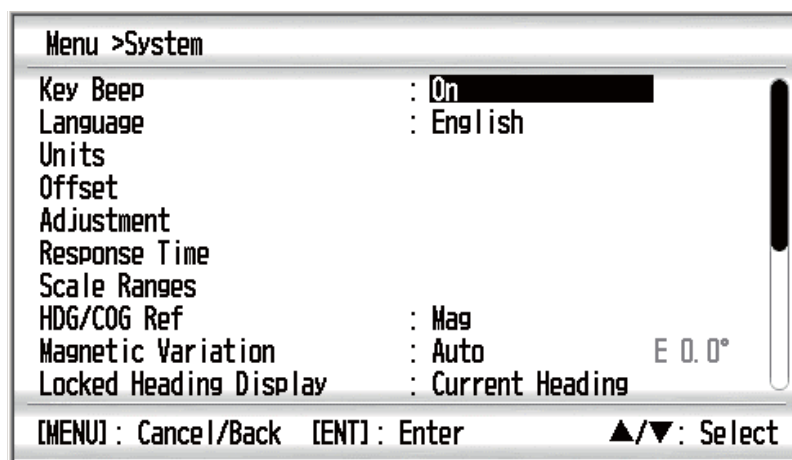

3. Use the Cursorpad (▲ or ▼) to select [Units] and press the **ENT** key.

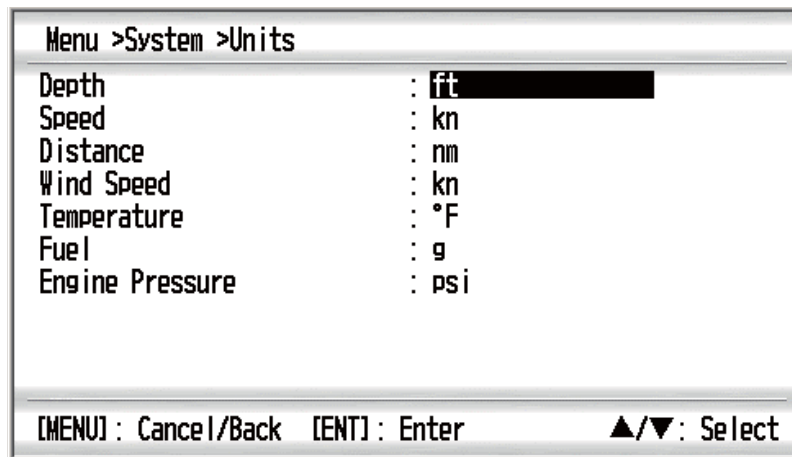

7. SYSTEM MENU

- Use the Cursorpad (▲ or ▼) to select [Depth], [Speed], [Distance], [Wind Speed], [Temperature], [Fuel] or [Engine Pressure] then press the **ENT** key.

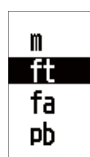

Depth

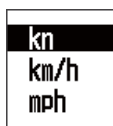

Speed

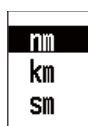

Distance

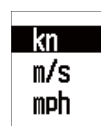

Wind Speed



Temperature



Fuel

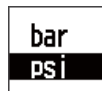

Engine Pressure

- Use the Cursorpad (▲ or ▼) to select an option and press the **ENT** key.
- Press the **DISP** key to close the menu and display the data screen.

7.2 How to Set the Offset

Offset for depth, wind angle and water temperature

When there is an error of constant value for depth, wind angle or water temperature data, you can set the offset to eliminate an error. For example, enter -1.5 °F when the water temperature is always displayed at 1.5 °F higher than the actual temperature.

- Press the **MENU** key to open the menu.
- Use the Cursorpad (▲ or ▼) to select [System] and press the **ENT** key.
- Use the Cursorpad (▲ or ▼) to select [Offset] and press the **ENT** key.

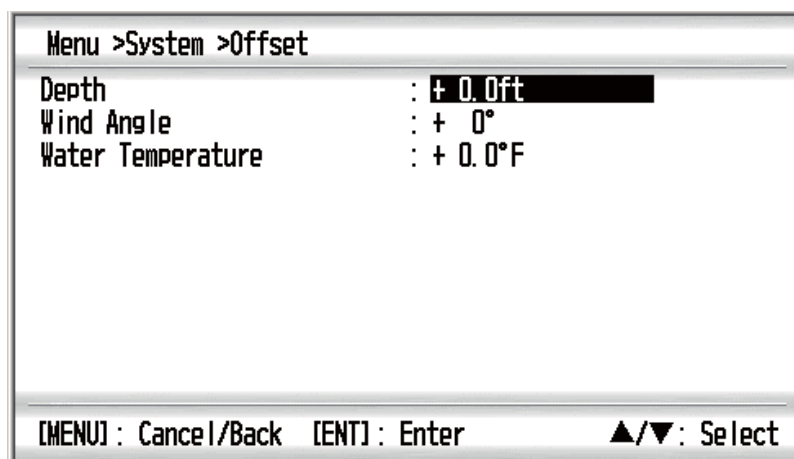

- Use the Cursorpad (▲ or ▼) to select [Depth], [Wind Angle] or [Water Temperature] then press the **ENT** key.



Depth



Wind Angle



Water Temperature

Setting window

- Use the Cursorpad (▲ or ▼) to select [+] or [-] then use the Cursorpad (▶) to move the cursor to the right.

6. Use the Cursorpad (▲ or ▼) to set the value and use the Cursorpad (▶) to move the cursor to the next digit. Repeat this step to set the value for other digits if necessary. When the displayed data is smaller than the actual value, set the plus value. When the displayed data is larger than the actual value, set the minus value.
7. Press the **ENT** key to save the setting and close the setting window. To close the window without saving, press the **MENU** key (instead of the **ENT** key).
8. Press the **DISP** key to close the menu and display the data screen.

Offset for STW and wind speed

When there is an error of proportional rate for STW or wind speed data, you can set the offset to eliminate an error. For example, enter 0.91 when the STW is always displayed at 10% faster than the actual speed.

1. Press the **MENU** key to open the menu.
2. Use the Cursorpad (▲ or ▼) to select [System] and press the **ENT** key.
3. Use the Cursorpad (▲ or ▼) to select [Adjustment] and press the **ENT** key.

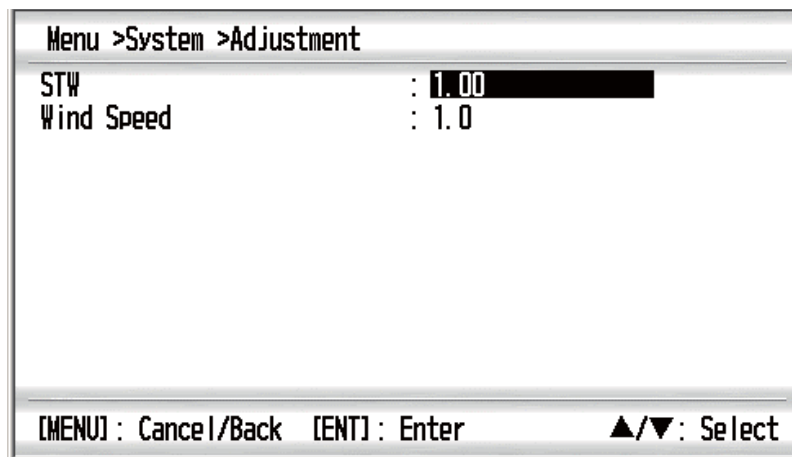

4. Use the Cursorpad (▲ or ▼) to select [STW] or [Wind Speed] then press the **ENT** key.
5. Use the Cursorpad (▲ or ▼) to set the value and use the Cursorpad (▶) to move the cursor to the next digit. Repeat this step to set the value for other digits if necessary (setting range for [STW]: 0.30 - 2.50, setting range for [Wind Speed]: 0.3 - 2.5). When the displayed data is smaller than the actual value, set the value which is larger than 1.0. When the displayed data is larger than the actual value, set the value which is smaller than 1.0. The value "1" means no offset.
6. Press the **ENT** key to save the setting and close the setting window. To close the window without saving, press the **MENU** key (instead of the **ENT** key).
7. Press the **DISP** key to close the menu and display the data screen.

7.3 Response Time

You can set the response time for each data as follows. The input raw data is averaged by the response time.

1. Press the **MENU** key to open the menu.
2. Use the Cursorpad (▲ or ▼) to select [System] and press the **ENT** key.
3. Use the Cursorpad (▲ or ▼) to select [Response Time] and press the **ENT** key.

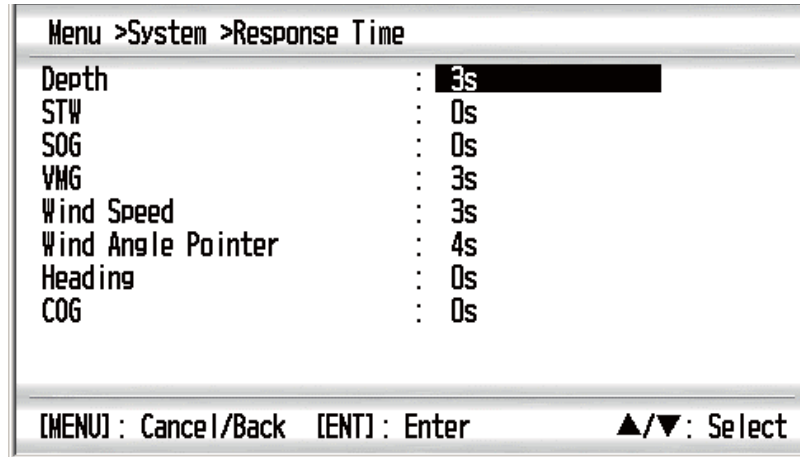

4. Use the Cursorpad (▲ or ▼) to select the menu item desired and press the **ENT** key.

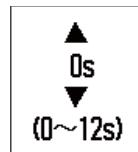

5. Use the Cursorpad (▲ or ▼) to set the value and press the **ENT** key to save the setting. To close the window without saving, press the **MENU** key (instead of the **ENT** key). The setting range is 0 - 12 seconds. The higher the setting, the slower the response of the display. "0" second means no average.
6. Press the **DISP** key to close the menu and display the data screen.

7.4 Scale Range

You can set the scale range for the analog meter.

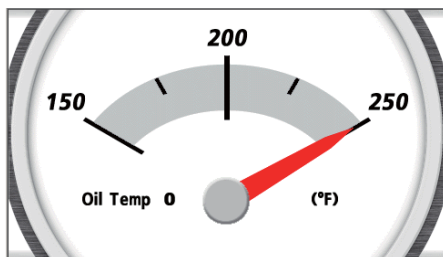

Engine Oil Temperature: 150-250°F

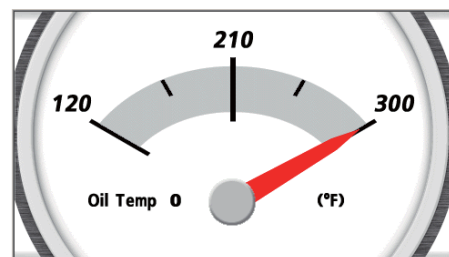

Engine Oil Temperature: 120-300°F

Example screens

1. Press the **MENU** key to open the menu.
2. Use the Cursorpad (▲ or ▼) to select [System] and press the **ENT** key.

- Use the Cursorpad (▲ or ▼) to select [Scale Ranges] and press the **ENT** key.

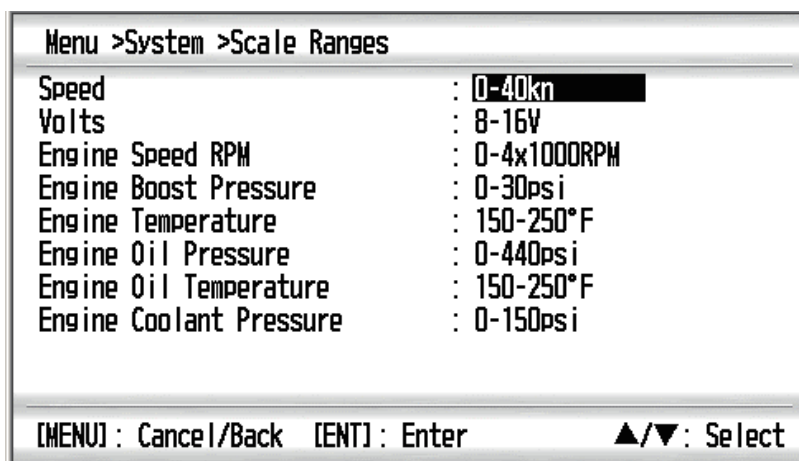

- Use the Cursorpad (▲ or ▼) to select the menu item desired and press the **ENT** key.
- Use the Cursorpad (▲ or ▼) to select an option and press the **ENT** key.

Menu item	Option
Speed	kn: 0-20kn, 0-40kn, 0-80kn km/h: 0-40km/h, 0-80km/h, 0-160km/h mph: 0-20mph, 0-40mph, 0-80mph
Volts	8-16V, 16-32V
Engine Speed RPM	0-40x100RPM, 0-60x100RPM, 0-80x100RPM
Engine Boost Pressure	psi: 0-30psi, 0-70psi, 0-150psi, 0-360psi, 0-440psi bar: 0-2bar, 0-5bar, 0-10bar, 0-25bar, 0-30bar
Engine Temperature	°F: 150-250°F, 120-300°F °C: 60-120°C, 50-150°C
Engine Oil Pressure	psi: 0-30psi, 0-70psi, 0-150psi, 0-360psi, 0-440psi bar: 0-2bar, 0-5bar, 0-10bar, 0-25bar, 0-30bar
Engine Oil Temperature	°F: 150-250°F, 120-300°F °C: 60-120°C, 50-150°C
Engine Coolant Pressure	psi: 0-30psi, 0-70psi, 0-150psi, 0-360psi, 0-440psi bar: 0-2bar, 0-5bar, 0-10bar, 0-25bar, 0-30bar

- Press the **DISP** key to close the menu and display the data screen.

7.5 Setting for Time and Date

Display format for time and date

You can select the display format for time and date.

- Press the **MENU** key to open the menu.
- Use the Cursorpad (▲ or ▼) to select [System] and press the **ENT** key.

7. SYSTEM MENU

- Use the Cursorpad (▲ or ▼) to select [Time Display] or [Date Display] then press the **ENT** key.



Time Display



Date Display

- Use the Cursorpad (▲ or ▼) to select an option and press the **ENT** key.
- Press the **DISP** key to close the menu and display the data screen.

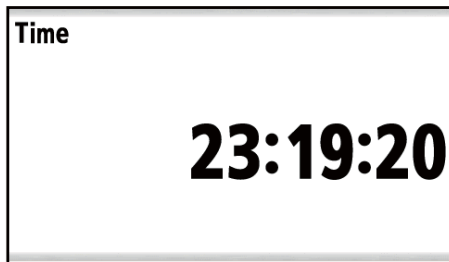

Time Display: 24Hour

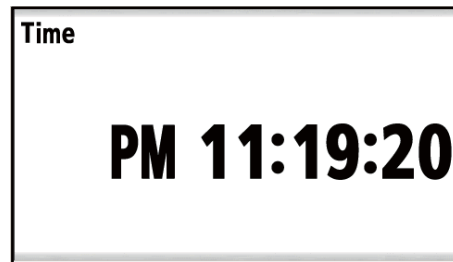

Time Display: 12Hour

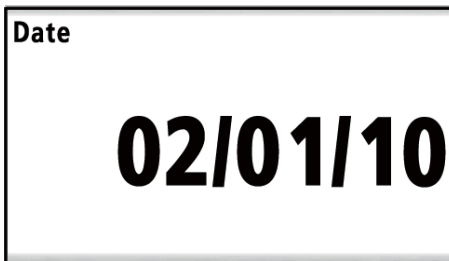

Date Display: MM/DD/YY



Date Display: DD/MMM/YY

Screen examples

Time difference

You can set the time differences from UTC (Universal Time Coordinated) at 15 minutes intervals to show the local time.

- Press the **MENU** key to open the menu.
- Use the Cursorpad (▲ or ▼) to select [System] and press the **ENT** key.
- Use the Cursorpad (▲ or ▼) to select [Time Offset] and press the **ENT** key.
- Use the Cursorpad (▲ or ▼) to set the time and press the **ENT** key. The setting range is -14:00 - +14:00.
- Press the **DISP** key to close the menu and display the data screen.

Daylight saving time

You can show the time in daylight saving time.

- Press the **MENU** key to open the menu.
- Use the Cursorpad (▲ or ▼) to select [System] and press the **ENT** key.
- Use the Cursorpad (▲ or ▼) to select [Daylight Saving Time] and press the **ENT** key.
- Use the Cursorpad (▲ or ▼) to select [On] and press the **ENT** key.
- Press the **DISP** key to close the menu and display the data screen.

7.6 Other Menu Items

This section describes the menu items not previously described.

[Key Beep]: When a key is pressed, a beep sounds. You can turn on or off this beep.

[Language]: English and other languages are available.

[HDG/COG Ref]: You can display the bearing in true or magnetic. [True] is the bearing measured using true North as the reference direction. "T" is displayed on the screen. [Mag] is the bearing measured with magnetic north as the reference direction. "M" is displayed on the screen.

[Magnetic Variation]: If you selected [Mag] on the previous menu item [HDG/COG Ref], set the option of the [Magnetic Variation]. The location of the magnetic north pole is different from the geographical north pole. This causes a difference between the true and magnetic north direction. This difference is called magnetic variation, and varies with respect to the observation point on earth. Your unit is preprogrammed with all the earth's magnetic variation. If you selected [Auto], the programmed value is used to display magnetic bearing. However, you can enter variation manually to improve accuracy, referring to the latest navigation chart. Select [Manual] and press the **ENT** key. Use the Cursorpad (▶) to move the cursor to the right and enter the variation.

[Locked Heading Display]: At the [Locked HDG] analog screen, set the digital heading indication method.

[Current Heading]: Display the current heading.

[Locked Heading]: Display the locked heading at the moment that the **START/CLEAR** key is pressed.

[Locked Bearing Display]: At the [Locked BRG] analog screen, set the digital bearing indication method. (Bearing: From your ship to the destination waypoint)

[Current Bearing]: Display the current bearing from your ship to the destination waypoint.

[Locked Bearing]: Display the locked bearing at the moment that the **START/CLEAR** key is pressed.

[Trip · ODO]: Select the source for the trip and odometer indications, [Internal] or [External].

[Internal]: Use displayed value.

[External]: Use the value input from the external sensor.

[GWD Sensor Selection]: Select how to display the ground wind indication.

[Internal]: Use received true wind plus heading.

[External]: Use received true wind.

7. SYSTEM MENU

This page is intentionally left blank.

8. MAINTENANCE, TROUBLESHOOTING

NOTICE

Do not apply paint, anti-corrosive sealant or contact spray to plastic parts or equipment coating.

Those items contain products that can damage plastic parts and equipment coating.

8.1 Maintenance

Check the following points regularly to maintain performance:

- Check that connections on the rear panel are firmly tightened and free of dust.
- Check that the grounding point is free of rust and the ground wire is tightly fastened.
- Remove dust or dirt from the cabinet with a soft, dry cloth. For stubborn dirt, you can use water-diluted mild detergent. Clean the cabinet with a dry cloth after you use detergent. Do not use solvents like thinner, acetone or benzene to clean the unit. They can remove paint and indications.
- Wipe the LCD carefully to prevent scratching, using tissue paper and an LCD cleaner. To remove dirt or salt deposits, use an LCD cleaner, wiping slowly with tissue paper so as to dissolve the dirt or salt. Change paper frequently so the salt or dirt will not scratch the LCD. Do not use solvents such as thinner, acetone or benzene for cleaning. Also, do not use degreaser or antifog solution, as they can strip the coating from the LCD.

LCD life

The life of the LCD is approximately 50,000 hours. The actual number of hours depends on ambient temperature and humidity. When the brilliance cannot be raised sufficiently, ask your dealer about replacement.

8.2 Troubleshooting

This section provides simple troubleshooting procedures which the user can follow to restore normal operation. If you cannot restore normal operation, do not check inside the unit. Have a qualified technician check the equipment.

Symptom	Remedy
You cannot turn on the power.	<ul style="list-style-type: none"> • Check that the power cable is firmly fastened. • Check for damaged power cable and connector.
No picture appears.	Press the  key several times to adjust the screen brilliance.
There is no response when a key is pressed.	Turn off and on the power then operate the key. If you do not get a response, the key is damaged. Contact your dealer for instructions.
No data appears.	Check that the connectors of sensors are firmly fastened.

8.3 Test

The test checks the system for correct operation.

1. Press the **MENU** key to open the menu.
2. Use the Cursorpad (**▲** or **▼**) to select [System] and press the **ENT** key.
3. Use the Cursorpad (**▲** or **▼**) to select [Self Test] and press the **ENT** key.



4. Use the Cursorpad (**▲** or **▼**) to select [System Test] and press the **ENT** key.

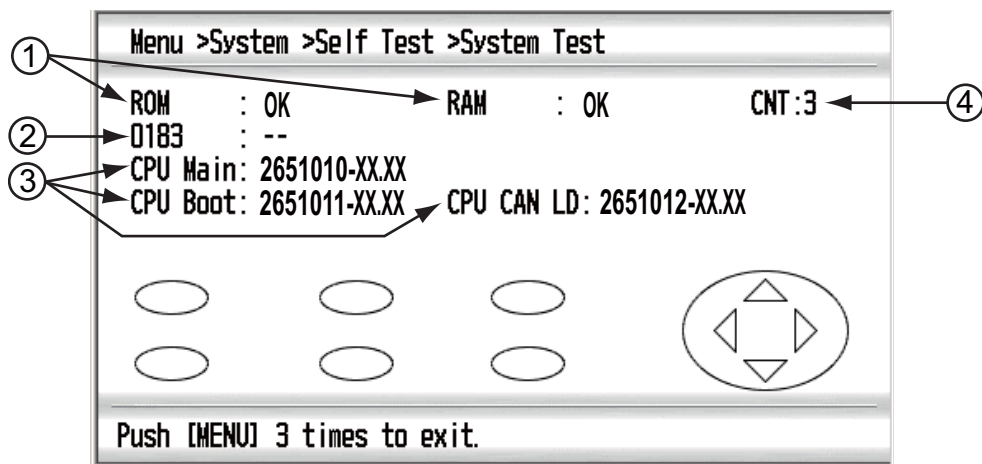

XX.XX: Program version number

System Test items

No.	Items	Description
1	ROM, RAM	The results of the ROM/RAM test are displayed as "OK" or "NG" (No Good). If any NG is displayed, contact your dealer.
2	0183	The result of the port NMEA 0183 is displayed as "OK" or "--". Port NMEA 0183 requires a special connector to test it. When a special connector is not connected, "--" is shown.
3	Program version (CPU Main, CPU Boot, CPU CAN LD)	Each program number and program version number are displayed.
4	CNT	The number of times for diagnostic test is displayed.

5. Press each key or arrow one by one. A key's or arrow's on-screen location turns to red if the key or arrow is normal. When you press a key or arrow again, red turns to white.
6. Press the **MENU** key three times to escape from the system test.
7. Use the Cursorpad (▲ or ▼) to select [LCD Test] and press the **ENT** key to execute the LCD test. The red pattern appears.
8. Press the **ENT** key continuously. The screen changes as follows.

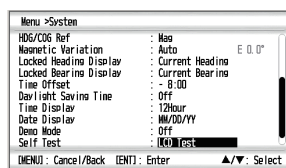
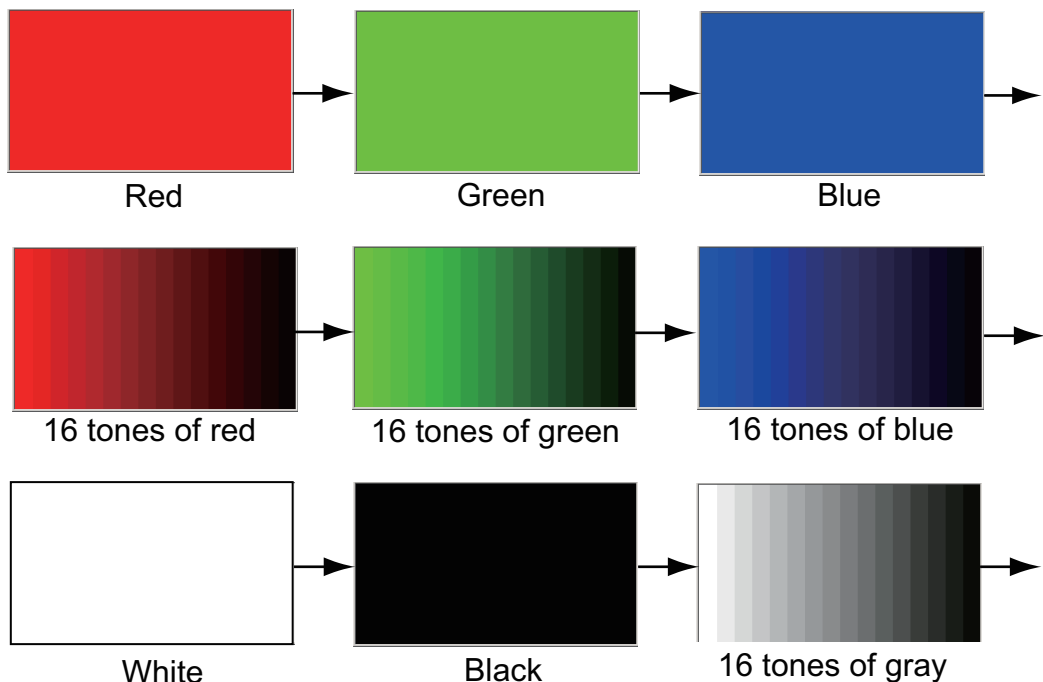

[System] menu

9. Press the **DISP** key to close the menu and display the data screen.

8.4 Factory Reset

You can restore all settings as follows:

1. Press the **MENU** key to open the menu.
2. Use the Cursorpad (▲ or ▼) to select [System] and press the **ENT** key.
3. Use the Cursorpad (▲ or ▼) to select [Factory Reset] and press the **ENT** key.
4. Use the Cursorpad (▲ or ▼) to select [On] and press the **ENT** key. The confirmation message appears.

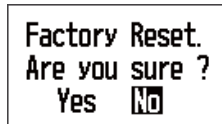

5. Use the Cursorpad (◀) to select [Yes] and press the **ENT** key. The equipment re-starts with the default settings. The [Installation] menu screen appears.

8.5 Demo Mode

A demo mode, which shows internally generated navigation data, is provided to acquaint you with the features of the RD-33. "SIM" (simulation) appears on the screen when the demo mode is turned on.

1. Press the **MENU** key to open the menu.
2. Use the Cursorpad (▲ or ▼) to select [System] and press the **ENT** key.
3. Use the Cursorpad (▲ or ▼) to select [Demo Mode] and press the **ENT** key.
4. Use the Cursorpad (▲ or ▼) to select [On] and press the **ENT** key.
5. Press the **DISP** key to close the menu and display the data screen.

9. INSTALLATION

9.1 Equipment List

Standard supply

Name	Type	Code No.	Qty	Remarks
Remote Display	RD-33	-	1	
Installation Materials	CP20-03300	-	1	<ul style="list-style-type: none"> • CP20-03310* • M12-05BM+05BF-060
Accessories	FP20-01200*	001-087-250	1	*: See page A-1.

Optional supply

Name	Type	Code No.	Remarks
Junction Box	FI-5002	-	
Cable Assy.	FI-50-CHAIN-0.3M	000-166-949-11	CAN bus, w/0.3 m cable, connector at both ends
	FI-50-CHAIN-1M	000-166-950-11	1 m
	FI-50-CHAIN-5M	000-166-951-11	5 m
	FI-50-CHAIN-10M	000-166-952-11	10 m
	FI-50-CHAIN-20M	000-166-953-11	20 m
Cable Assy.	MJ-A6SPF0003-020C	000-154-029-10	For NMEA 0183, w/2 m cable, connector at one end 6P
	MJ-A6SPF0003-050C	000-154-054-10	5 m
	MJ-A6SPF0003-100C	000-168-924-10	10 m
	MJ-A6SPF0003-150C	000-159-643-10	15 m
Cable Assy.	M12-05BM+05BF-010	000-167-962-11	CAN bus, w/1 m cable, connector at both ends
	M12-05BM+05BF-020	000-167-963-11	2 m
	M12-05BM+05BF-060	000-167-964-11	6 m
Micro T-connector	SS-050505-FMF-TS001	000-168-603-10	For CAN bus network
Mini/Micro T-connector	NC-050505-FMF-TS001	000-160-507-10	
Cover-Up Bezel	OP20-38	001-156-750	Kit for upgrading RD-30 to RD-33

9.2 Installation

Mounting considerations

The remote display can be installed on a desktop, on the underside of a table, or flush mounted in a panel. When you select a mounting location, remember the following points:

- The nominal viewing distance for the display unit is 0.6 m. Select a suitable mounting location considering that distance.
- Locate the remote display away from exhaust pipes and vents.
- Select an installation location that is well ventilated.
- Locate the remote display where shock and vibration are minimal.
- Locate the remote display away from equipment which generates the electromagnetic fields like a motor or generator.
- Allow enough maintenance space at the sides and rear of the remote display and leave enough slack in cables to facilitate maintenance and servicing.
- Observe the compass safe distances (see page ii) to prevent the interference to a magnetic compass.

Flush mounting

See the outline drawing in the back of this manual.

1. Make a cutout in the mounting location using the template.

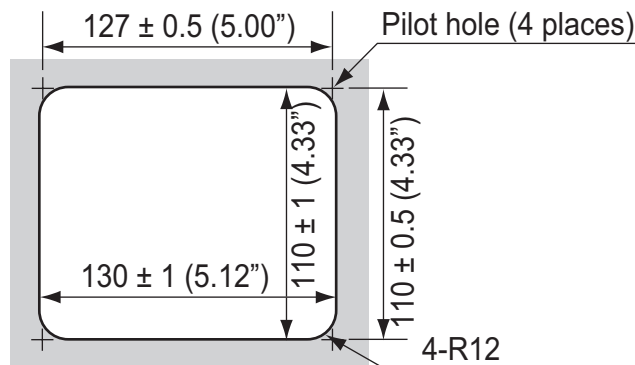

2. Make four pilot holes for self-tapping screws (3x20) in the mounting location.
3. Remove the hanger assembly from the remote display. Discard the hanger assembly.
4. Remove the front panel from the remote display by unfastening the catches at the rear of the panel by hands, in the order shown in the figure below.

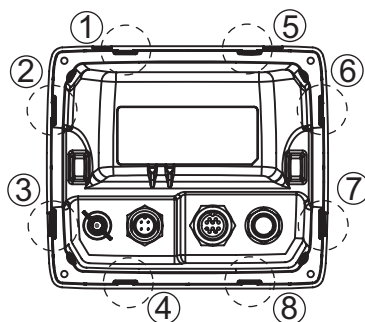

5. Attach the F mount cushion (supplied as accessories) to the remote display from the rear side.
6. Connect the cable connectors (see section 9.3).
7. Set the remote display to the cutout and fasten it with four self-tapping screws (supplied as installation material; 3x20).
8. Set the front panel to the remote display.

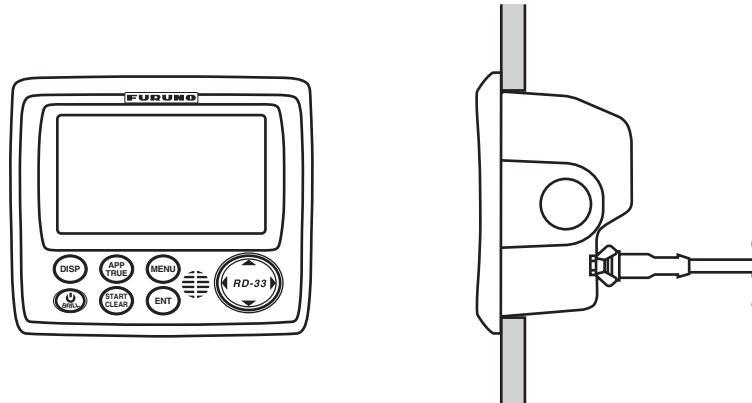

Note: When you remove the remote display from the flush mounting location, use the panel remover (supplied as accessories) to remove the panel as shown below.

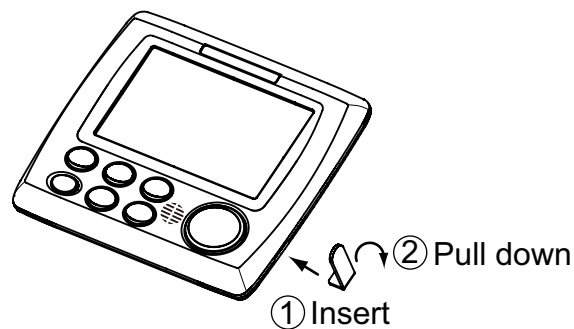

Desktop or table underside mounting

See the outline drawing in the back of this manual.

1. Make four pilot holes for self-tapping screws (5x20) in the mounting location.
2. Remove the hanger assembly from the remote display.
3. Connect the cable connectors (see section 9.3).
4. Fix the hanger to the mounting location with four self-tapping screws (supplied as installation material; 5x20).
5. Set the remote display to the hanger.

9. INSTALLATION

6. Tighten the knobs to fasten the hanger to the remote display.

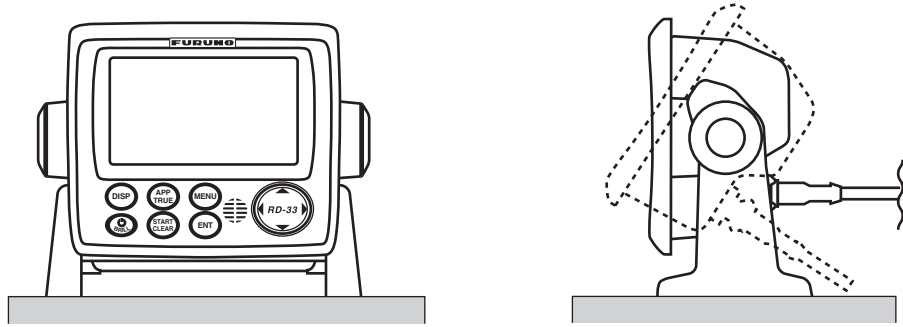

9.3 Wiring

Refer to the following illustration and the interconnection diagram (page S-1) to connect cables.

Note: The remote display power is supplied through CAN bus. When the sensor signal is input or output only from the NMEA 0183 device without the CAN bus device, connect the 12-24 VDC power from the ship's switch board to the male connector of the CAN bus port.

Interconnection

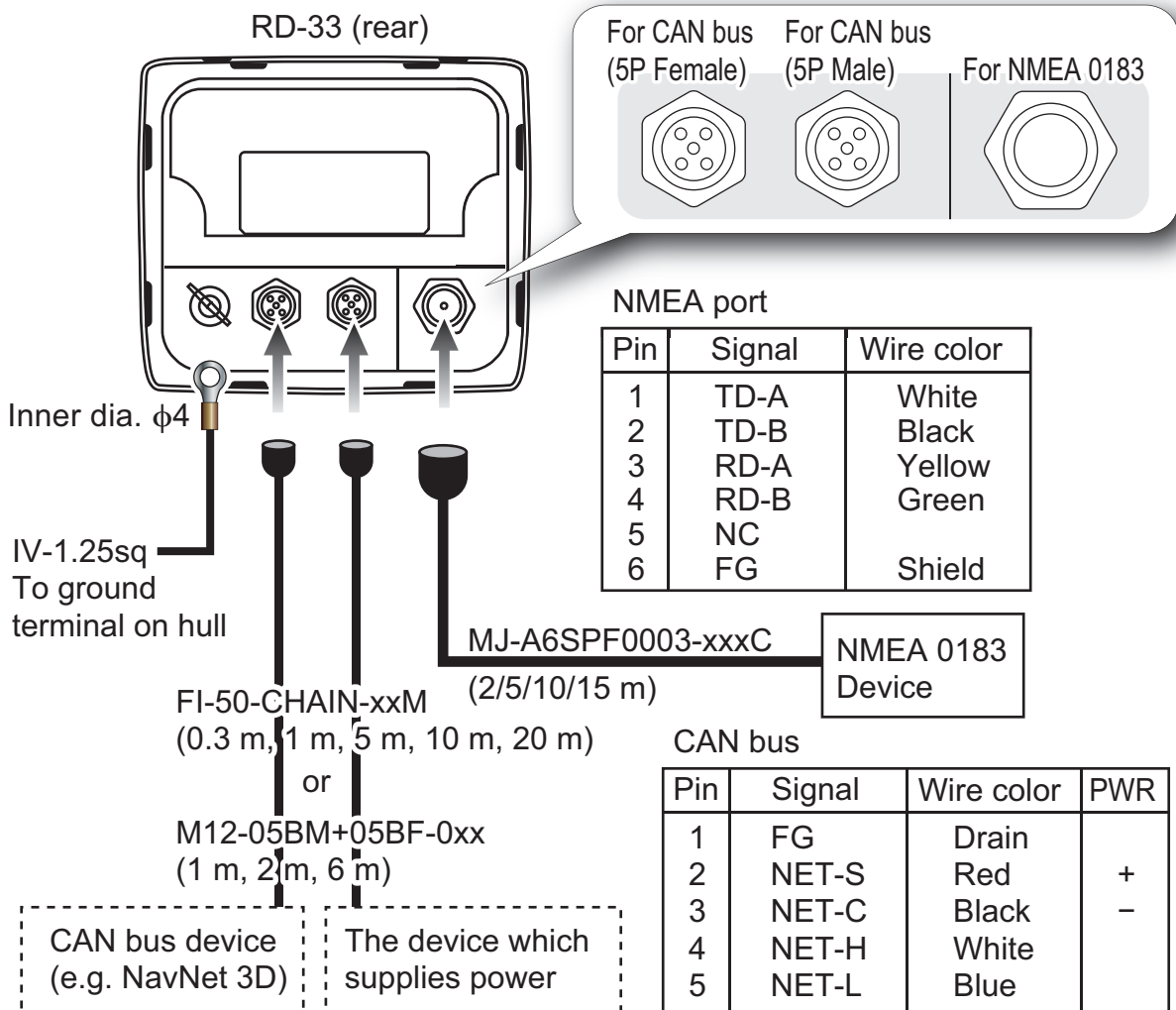

Connection between remote display and junction box

For serviceman: See “Furuno CAN bus Network Design Guide” (TIE-00170-X) for details about CAN bus network.

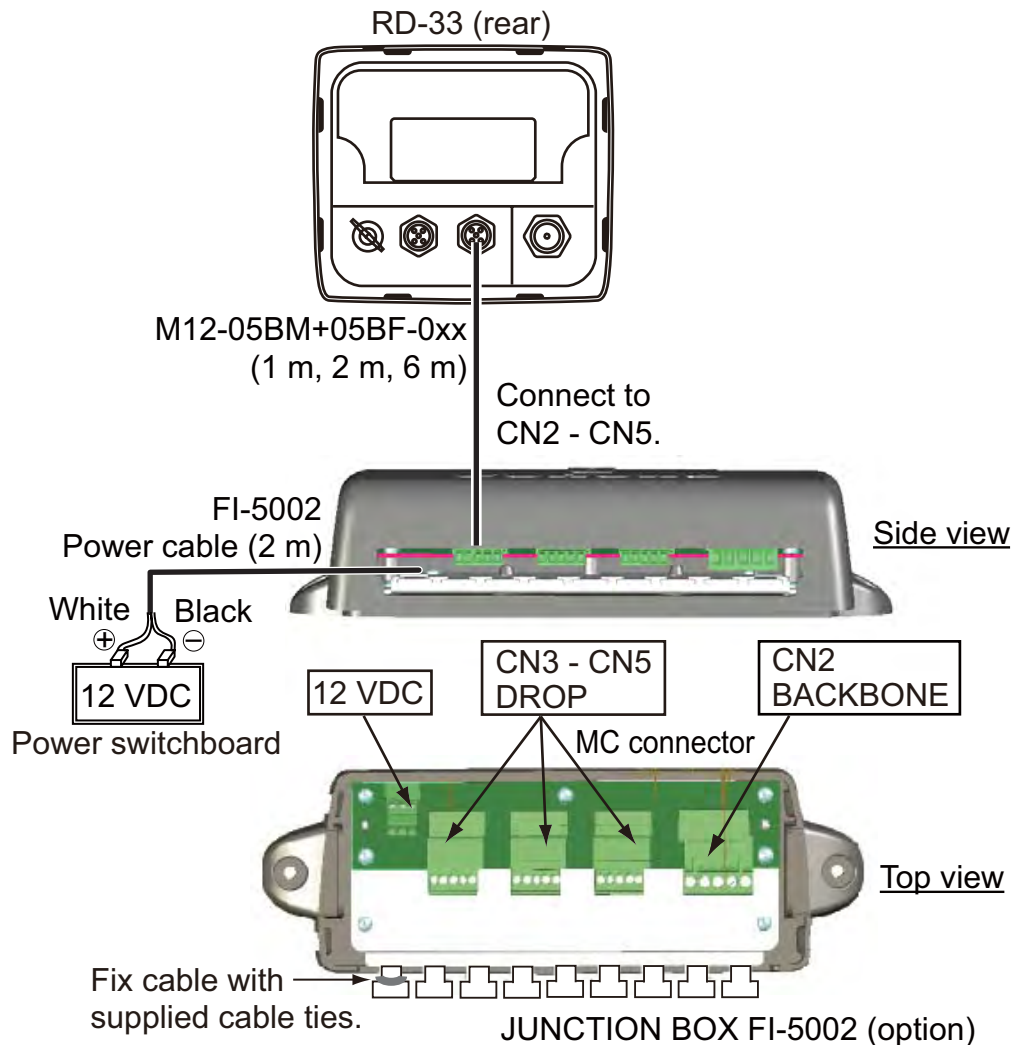

Fabrication of cable M12-05BM+05BF-060 and connection to MC connector

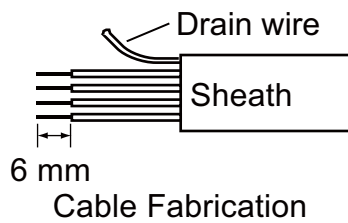

Wire	Conn. Pt.
Drain	1
Red	2
Black	3
White	4
Blue	5

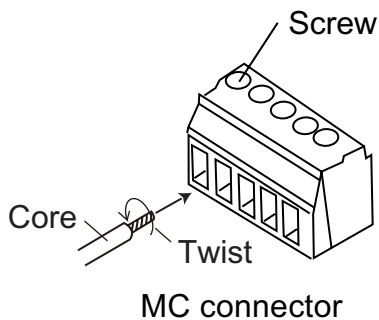

How to insert cores:

1. Twist the cores.
2. Unfasten the screw with Philips head screwdriver.
3. Set the core to hole.
4. Tighten the screw.
5. Pull the wire to confirm connection.

Terminator

- Connection to the backbone cable

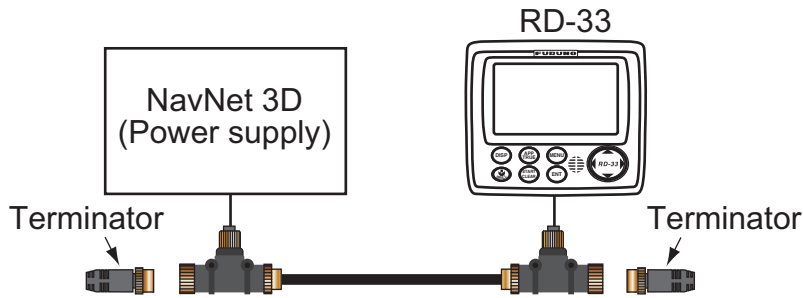

Furuno CAN bus terminators are available with the following part numbers. The terminator should be attached at each end of the backbone cable.

Parts name	Type	Code Number	Remarks
Male terminator	LTWMN-05AMMT-SL8001	000-160-508-10	Mini connector
Female terminator	LTWMN-05AFFT-SL8001	000-160-509-10	Mini connector
Male terminator	LTWMC-05BMMT-SL8001	000-168-604-10	Micro connector
Female terminator	LTWMC-05BFFT-SL8001	000-168-605-10	Micro connector

- Connection to the Junction box FI-5002
 - The FI-5002 has two terminal resistors (R1, R2).
 - 1) When no backbone cable is connected, R1 and R2 are set to ON position.
 - 2) When one backbone cable is connected, either R1 or R2 is set to ON position.
 - 3) When two backbone cables are connected, R1 and R2 are set to OFF position.

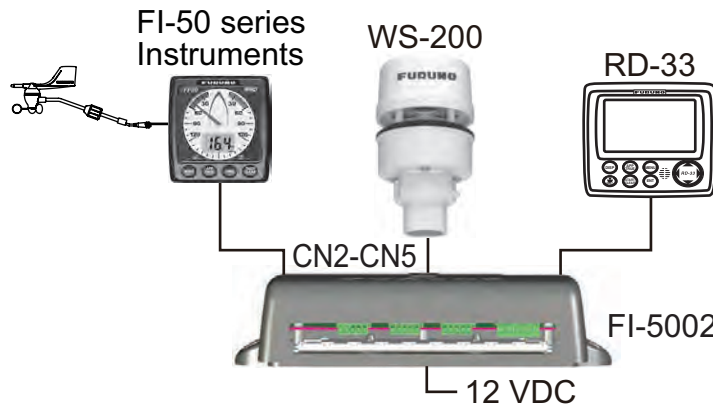

Internal Terminators in FI-5002

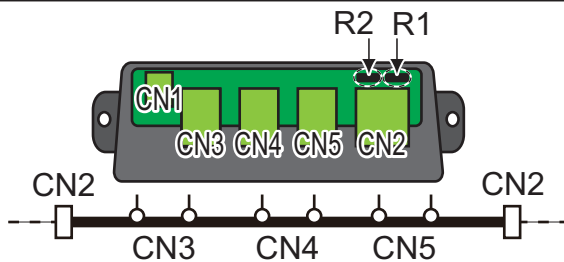
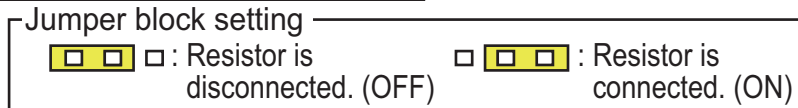

9.4 Adjustments

After you install the remote display, initialize the remote display as follows:

1. Press the  key to turn on the power.

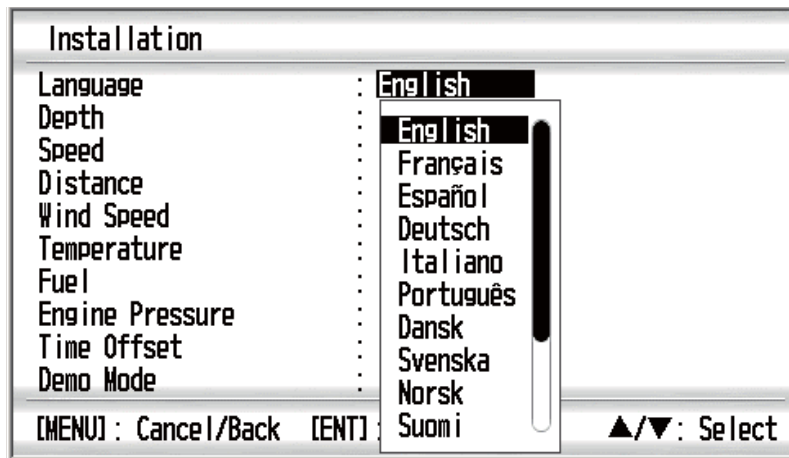

2. Press the **ENT** key with the cursor on [English]. The menu for units of measurement appears.

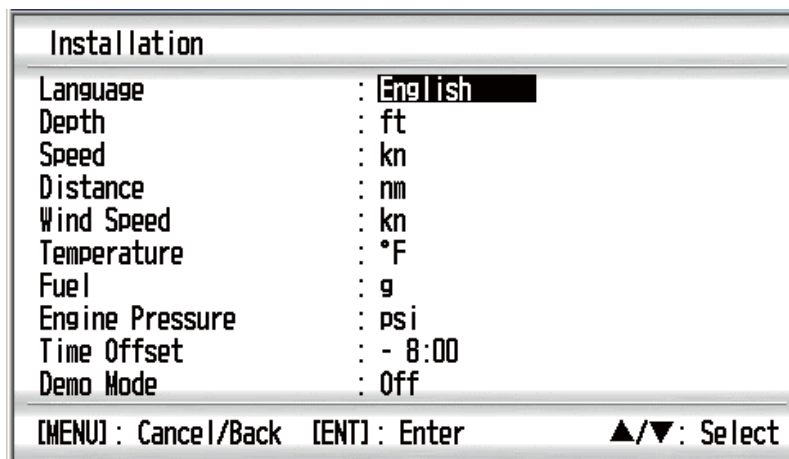

3. Use the Cursorpad (▲ or ▼) to select the menu item desired and press the **ENT** key.

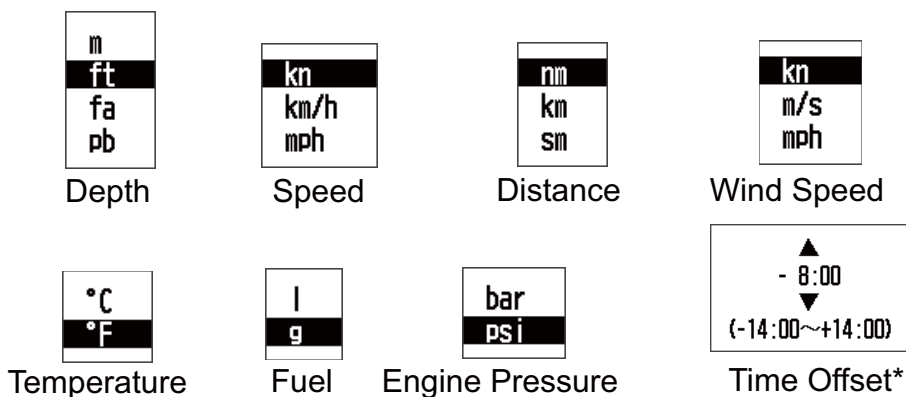

*: Set the difference between UTC (Universal time coordinated) and local time.

4. Use the Cursorpad (▲ or ▼) to select an option and press the **ENT** key.
5. Press the **MENU** key to close the menu.

9.5 Input/Output Signal

The RD-33 inputs and outputs the signal in NMEA 0183 and CAN bus format.

Input signal

Data	Port	Sentence, PGN (Title)
Depth	CAN bus	128267 (Water depth)
	NMEA 0183	DPT>DBT>DBS>DBK
STW (Speed Through the Water)	CAN bus	128259 (Speed, Water referenced), 130577 (Direction data)
	NMEA 0183	VHW>VBW
SOG (Speed Over the Ground)	CAN bus	128259 (Speed, Water referenced), 130577 (Direction data)
	NMEA 0183	VTG>RMC>RMA>VBW
Wind speed and angle (Apparent)	CAN bus	130306 (Wind data)
	NMEA 0183	MWV(A)>VWR
Wind speed and angle (True)	CAN bus	130306 (Wind data)
	NMEA 0183	MWV(T)>VWT
Heading (True)	CAN bus	127250 (Vessel heading), 130577 (Direction data)
	NMEA 0183	HDT(T)>PFEC,Gpatt(T)>VHW(T)> HDG(M,V,D)
Heading (Magnetic)	CAN bus	127250 (Vessel heading), 130577 (Direction data)
	NMEA 0183	HDG(M,V,D)>HDM(M)>VHW(M)
Course (True)	CAN bus	129026 (COG & SOG, Rapid Update), 130577 (Direction data)
	NMEA 0183	VTG>RMC>RMA
Course (Magnetic)	CAN bus	129026 (COG & SOG, Rapid Update), 130577 (Direction data)
	NMEA 0183	VTG
ROT (Rate of Turn)	CAN bus	127251 (Rate of Turn)
	NMEA 0183	ROT
BRG (Bearing, True)	CAN bus	129284 (Navigation data)
	NMEA 0183	APB>RMB(T)>BWC(T)>BWR(T)
BRG (Bearing, Magnetic)	CAN bus	129284 (Navigation data)
	NMEA 0183	APB>BWC(M)>BWR(M)
RNG (Range)	CAN bus	129284 (Navigation data)
	NMEA 0183	RMB>BWC>BWR

Data	Port	Sentence, PGN (Title)
XTE (Cross-Track Error)	CAN bus	129283 (Cross-Track Error)
	NMEA 0183	XTE>APB>RMB
WP Number	CAN bus	129284 (Navigation data), 129285 (Navigation-Route/WP information)
	NMEA 0183	-
WP Name	CAN bus	129285 (Navigation-Route/WP information)
	NMEA 0183	RMB>APB>BWC>BWR>ZTG
Longitude/Latitude	CAN bus	129029 (GNSS Position data), 129025 (Position, Rapid Update)
	NMEA 0183	GNS > GGA > RMC > RMA > GLL
Longitude/Latitude for way-point	CAN bus	129284 (Navigation data)
	NMEA 0183	RMB > BWR > BWC
Number of acquired satellites	CAN bus	129029 (GNSS Position data)
	NMEA 0183	GNS>GGA
Pitch/Roll	CAN bus	127257 (Attitude)
	NMEA 0183	PFEC,GPatt
ETA Time&Date	CAN bus	129284 (Navigation data)
	NMEA 0183	ZTG
Time difference	CAN bus	130052 (Loran C TD data)
	NMEA 0183	GLC >GTD
Date	CAN bus	126992 (System time), 129033 (Time & Date)
	NMEA 0183	ZDA>RMC
Time	CAN bus	126992 (System time), 129033 (Time & Date)
	NMEA 0183	ZDA>RMC
Water temperature	CAN bus	130310 (Environmental Parameters), 130311 (Environmental Parameters)
	NMEA 0183	MTW > MDA
Temperature	CAN bus	130310 (Environmental Parameters) 130311 (Environmental Parameters)
	NMEA 0183	MDA
Atmosphere	CAN bus	130310 (Environmental Parameters), 130311 (Environmental Parameters)
	NMEA 0183	MDA

9. INSTALLATION

Data	Port	Sentence, PGN (Title)
Humidity	CAN bus	130311 (Environmental Parameters)
	NMEA 0183	MDA
Rudder	CAN bus	127245 (Rudder)
	NMEA 0183	RSA
Engine	CAN bus	127497 (Trip Parameters, Engine), 127488 (Engine Parameters, Rapid Update), 127489 (Engine Parameters, Dynamic)
	NMEA 0183	-
Current (tide)	CAN bus	-
	NMEA 0183	CUR > VDR

Note 1: >: The priority of the left sentence is higher than the one of right sentence.

Note 2: CAN bus>NMEA 0183

Output signal

Note: When Mix is active, the inputted NMEA0183 data is outputted in NMEA0183 format.

Data	Port	Sentence, PGN (Title)
Depth	CAN→0183	128267→DPT
	0183→CAN	DPT>DBT>DBS>DBK→128267
STW (Speed Through the Water)	CAN→0183	128259, 130577→VHW
	0183→CAN	VHW→128259
SOG (Speed Over the Ground)	CAN→0183	128259, 130577→VTG, RMC
	0183→CAN	VTG>RMC>RMA→128259
Wind speed and angle (Apparent)*1	CAN→0183	130306→MWV(A)
	0183→CAN	MWV(A)>VWR→130306
Wind speed and angle (True)*1	CAN→0183	130306→MWV(T)
	0183→CAN	MWV(T)>VWT→130306
Heading (True)*2	CAN→0183	127250, 130577→HDT, VHW(T)
	0183→CAN3	HDT>PFEC,Gpatt>VHW(T)→127250
Heading (Magnetic)*2	CAN→0183	127250, 130577→HDG, VHW(M)
	0183→CAN	HDG>HDM>VHW(M)→127250
Variation	CAN→0183	127250, 127258→HDG, RMC
	0183→CAN	HDG→127250
Deviation	CAN→0183	127250→HDG
	0183→CAN	HDG→127250

Data	Port	Sentence, PGN (Title)
Course (True)*2	CAN→0183	129026, 130577→VTG, RMC
	0183→CAN	VTG(T)>RMC>RMA→129026
Course (Magnetic)*2	CAN→0183	129026, 130577→VTG
	0183→CAN	VTG(M)→129026
ROT (Rate of Turn)	CAN→0183	-
	0183→CAN	-
BRG (Bearing, True)	CAN→0183	-
	0183→CAN	-
BRG (Bearing, Magnetic)	CAN→0183	-
	0183→CAN	-
RNG (Range)	CAN→0183	-
	0183→CAN	-
XTE (Cross-Track Error)	CAN→0183	129283→XTE
	0183→CAN	XTE>APB>RMB→129283
WP Number/Name	CAN→0183	-
	0183→CAN	-
Longitude/Latitude	CAN→0183	129025>129029→RMC
	0183→CAN	GNS>GGA>RMC>RMA>GLL →129029
Longitude/Latitude for destination waypoint	CAN→0183	-
	0183→CAN	-
Number of acquired satellites	CAN→0183	-
	0183→CAN	GNS>GGA→129029
Pitch/Roll	CAN→0183	-
	0183→CAN	-
ETA Time&Date	CAN→0183	-
	0183→CAN	-
Time difference	CAN→0183	-
	0183→CAN	-
Date	CAN→0183	126992, 129033→RMC
	0183→CAN	ZDA>RMC→126992
Time	CAN→0183	126992, 129033→RMC
	0183→CAN	ZDA>RMC→126992

9. INSTALLATION

Data	Port	Sentence, PGN (Title)
Water temperature	CAN→0183	130310, 130311→MTW
	0183→CAN	MTW > MDA→130311
Temperature	CAN→0183	-
	0183→CAN	MDA→130311
Atmosphere	CAN→0183	-
	0183→CAN	MDA→130311
Humidity	CAN→0183	-
	0183→CAN	MDA→130311
Rudder	CAN→0183	127245→RSA
	0183→CAN	RSA→127245
Engine	CAN→0183	-
	0183→CAN	-
Current (tide)	CAN→0183	-
	0183→CAN	-

*1: Apparent>True, *2: True>Magnetic

APPENDIX 1 MENU TREE

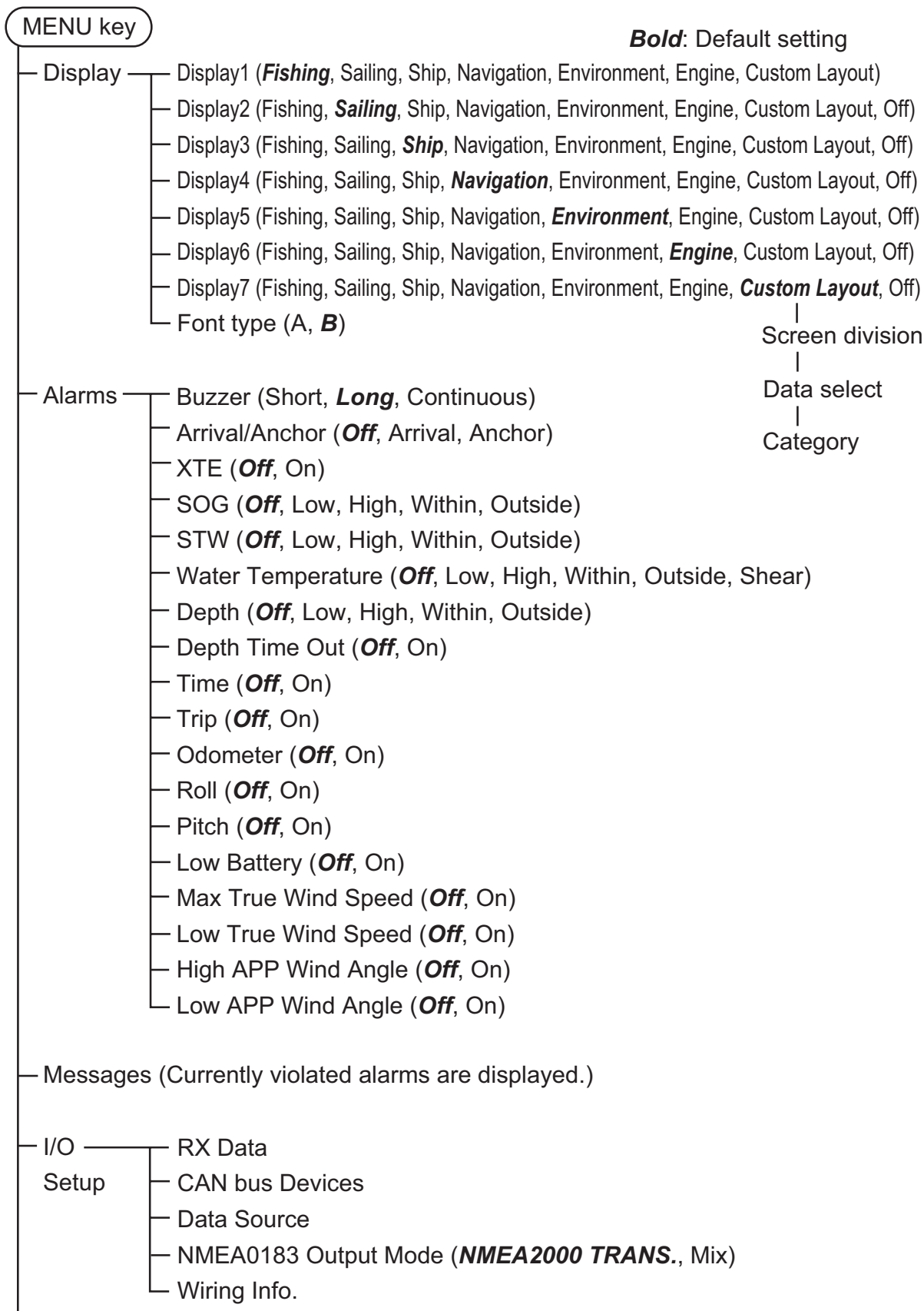

(Continued on next page)

(Continued from previous page)

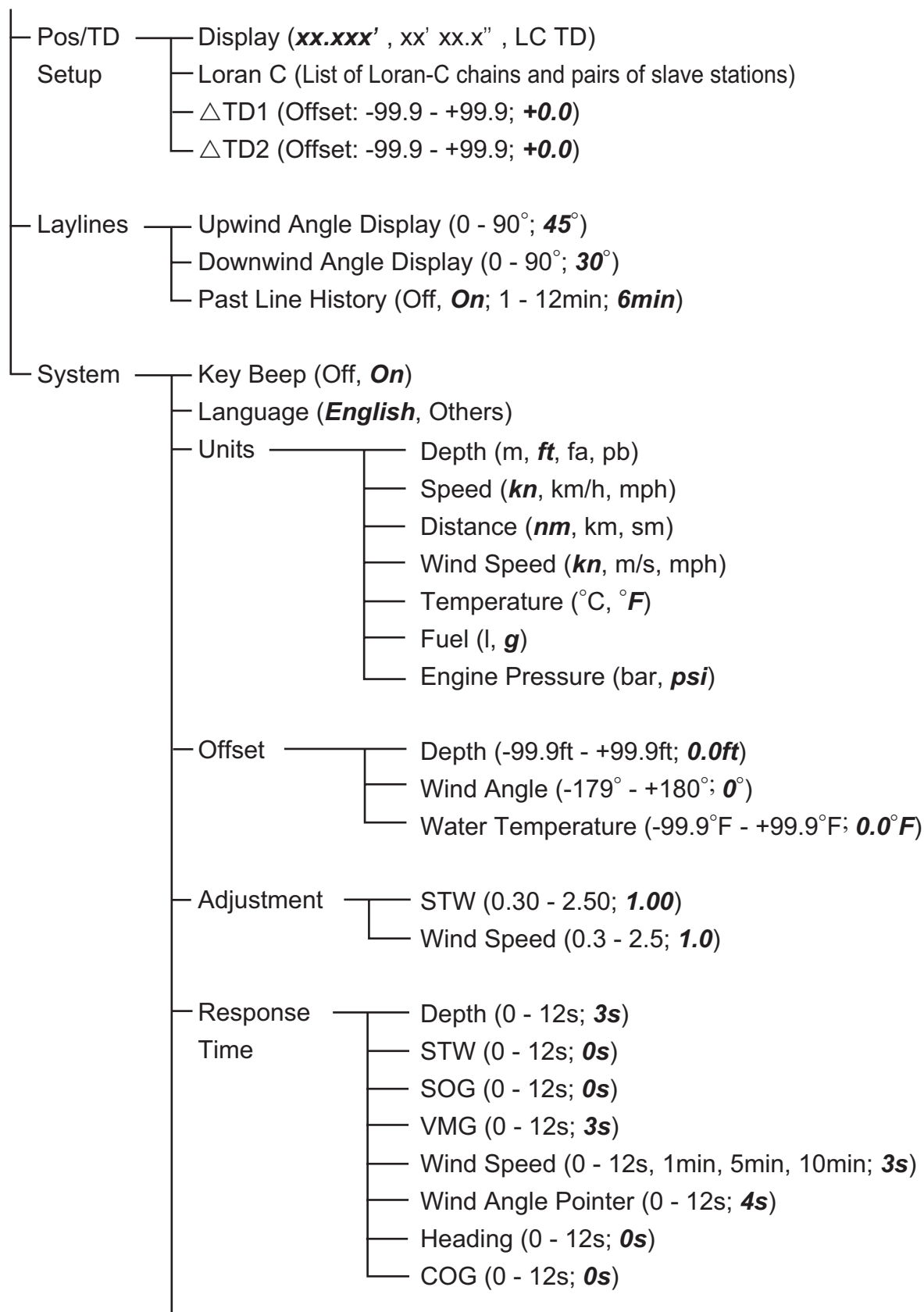

(Continued on next page)

(Continued from previous page)

- Scale ———— Speed (0-20kn, **0-40kn**, 0-80kn)
- Ranges ———— Volts (**8-16V**, 16-32V)
- Engine Speed RPM (**0-40x100RPM**, 0-60x100RPM, 0-80x100RPM)
- Engine Boost Pressure (**0-30psi**, 0-70psi, 0-150psi, 0-360psi, 0-440psi)
- Engine Temperature (**150-250°F**, 120-300°F)
- Engine Oil Pressure (0-30psi, 0-70psi, 0-150psi, 0-360psi, **0-440psi**)
- Engine Oil Temperature (**150-250°F**, 120-300°F)
- Engine Coolant Pressure (0-30psi, 0-70psi, **0-150psi**, 0-360psi, 0-440psi)

- HDG/COG Ref (True, **Mag**)
- Magnetic Variation (**Auto**, Manual)
- Locked Heading Display (Current Heading, **Locked Heading**)
- Locked Bearing Display (Current Bearing, **Locked Bearing**)
- Time Offset (-14:00 - +14:00; **-8:00**)
- Daylight Saving Time (**Off**, On)
- Time Display (12Hour, **24Hour**)
- Date Display (DD/MMM/YY, **MM/DD/YY**)
- Trip · ODO (Internal, **External**)
- GWD Sensor Selection (Internal, **External**)
- Demo Mode (**Off**, On)
- Self Test (**System Test**, LCD Test)
- Factory Reset (**Off**, On)

APPENDIX 2 LIST OF TERMS

The following table shows the terms used in the RD-33.

Term	Meaning
A(ir) Press	Air Pressure
Air Temp	Air Temperature
APP	Apparent: Apparent or relative wind. The wind direction relative to the ship's bow and the wind speed relative to the moving vessel.
AVG	Average
AWA	Apparent Wind Angle
AWS	Apparent Wind Speed
BFT	Beaufort Wind
BRG	Bearing
CMG	Course Made Good
CNT	Count
COG	Course Over the Ground
CUR	Current
Dest	Destination
DIR	Direction
DMG	Distance Made Good
ETA	Estimated Time of Arrival
E Temp	Engine Temperature
g	gallon
GW	Ground Wind
HDG	Heading
HUMID	Humidity
Info	Information
l	liter
Lat	Latitude
Lon	Longitude
M	Magnetic
MAX	Maximum
min	minute(s)
No.	Number
Odo	Odometer

Term	Meaning
Oil P	Oil Pressure
P	Port
POSN	Position
psi	Pound per square inch
RNG	Range
ROT	Rate Of Turn
RPM	Revolutions Per Minute
S	Starboard
s	second(s)
SAT	Satellite
SOG	Speed Over the Ground
SPD	Speed
STW	Speed Through the Water
STWAVG	Speed Through the Water Average
STWMAX	Speed Through the Water Maximum
T	True: True wind. The wind direction relative to the ship's bow and the wind speed as if the ship is stationary.
T	True: True bearing. The bearing measured using true North as the reference direction.
TD	Time difference: Position in Loran C
Temp	Temperature
TWA	True Wind Angle
TWS	True Wind Speed
VMG	Velocity Made Good
WPT	Waypoint
W Temp	Water Temperature
XTE	Cross-track Error

This page is intentionally left blank.

**SPECIFICATIONS OF REMOTE DISPLAY
RD-33**

1 GENERAL

- 1.1 Display type 4.3-inch color LCD, 480 x 272 dots (WQVGA)
- 1.2 Picture color 256 colors
- 1.3 Display mode Digital, Analog, Graph
- 1.4 Data indication Ship's speed, Course, Heading, Trip, Depth, Wind direction/speed, Navigate information, Environmental information, Rudder angle, Engine's information
- 1.5 Language Chinese, Danish, English, Finnish, French, German, Greek, Italian, Japanese, Norwegian, Portuguese, Spanish, Swedish, Thai

2 INTERFACE

- 2.1 Number of ports CAN bus: 2 ports, NMEA 0183: 1 port
- 2.2 Serial I/O NMEA0183 Ver3.0 (current loop)
 - Input data sentences APB,BWR,BWC,CUR,DBS,DBT,DBK,DPT,GGA,GLC,GLL,GNS, GTD,HDG,HDM,HDT,MTW,MDA,MWV,RMA,RMB,RMC,ROT, RSA,VBW,VDR,VHW,VTG,VWR,VWT,XTE,ZDA,ZTG
 - Output data sentences DPT,HDG,HDT,MTW,MWV,RMC,RSA,VHW,VTG,XTE
- 2.3 CAN bus PGN (NMEA2000)
 - Input 059904, 060928, 061184, 126208/720/992/996, 127245/250/251/257/258/488/489/493/497, 128259/267/275, 129025/026/029/033/283/284, 130306/310/311, 130052/577/821
 - Output 059392/904, 060928, 061184, 126208/464/720/992/996, 127245/250, 128259/267, 129026/029/283/284, 130306/311/821/822/823

3 POWER SUPPLY

- 3.1 CAN bus network 15 VDC: 0.26 A (LEN: 6)
- 3.2 Independently 12-24 VDC: 0.2-0.1 A

4 ENVIRONMENTAL CONDITION

- 4.1 Ambient temperature -15°C to +55°C
- 4.2 Relative humidity 93% at 40°C
- 4.3 Degree of protection IP56
- 4.4 Vibration IEC 60945

5 UNIT COLOR

N2.5

FURUNO

CODE NO.	001-087-240-00 **	20BE-X-9401 -1
TYPE	CP20-03310	1/1

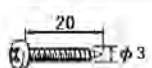
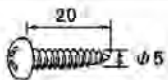
工事材料表 INSTALLATION MATERIALS		略 図 OUTLINE		型名/規格 DESCRIPTIONS		数量 Q'TY	用途/備考 REMARKS
GP-33/RD-33							
番号 NO.	名 称 NAME	略 図 OUTLINE		型名/規格 DESCRIPTIONS		数量 Q'TY	用途/備考 REMARKS
1	+selfタッピング 1/2φ SELF-TAPPING SCREW			3X20 SUS304 CODE NO. 000-163-884-10		4	
2	+5x20 selfタッピング 1/2φ SELF-TAPPING SCREW			5X20 SUS304 CODE NO. 000-162-608-10		4	

FURUNO

CODE NO.	001-087-250-00 **	20BE-X-9501 -2
TYPE	FP20-01200	1/1

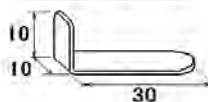
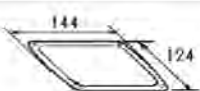
付属品表 ACCESSORIES		略 図 OUTLINE		型名/規格 DESCRIPTIONS		数量 Q'TY	用途/備考 REMARKS
GP-33/RD-33							
番号 NO.	名 称 NAME	略 図 OUTLINE		型名/規格 DESCRIPTIONS		数量 Q'TY	用途/備考 REMARKS
1	パネルリムーバー PANEL REMOVER			19-028-3124-1 CODE NO. 100-340-471-10		1	
2	F MOUNT CUSHION F MOUNT CUSHION			20-032-1064-1 CODE NO. 100-357-181-10		1	

コード番号末尾の[**]は、選択品の代表コードを表します。

CODE NUMBER ENDING WITH "**" INDICATES THE CODE NUMBER OF REPRESENTATIVE MATERIAL.

型式/コード番号が2段の場合、下段より上段に代わる過渡期品であり、どちらかが入っています。なお、品質は変わりません。

TWO TYPES AND CODES MAY BE LISTED FOR AN ITEM. THE LOWER PRODUCT MAY BE SHIPPED IN PLACE OF THE UPPER PRODUCT, QUALITY IS THE SAME.

(略図の寸法は、参考値です。 DIMENSIONS IN DRAWING FOR REFERENCE ONLY.)

FURUNO ELECTRIC CO., LTD.

取付穴
4-φ6

FIXING HOLES

146±0.5

63±0.5

88

15±2

型式銘板

NAMEPLATE

アース端子

GND TERMINAL

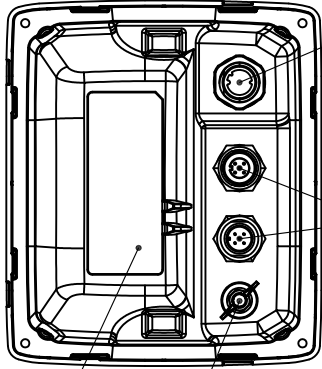

信号コネクタ (CANbus)
SIGNAL CONNECTOR

背面

信号コネクタ (NIMEA0183)
SIGNAL CONNECTOR

表 1 TABLE 1

寸法区分 (mm) DIMENSION	公差 (mm) TOLERANCE
L ≤ 50	±1.5
50 < L ≤ 100	±2.5
100 < L ≤ 500	±3

REAR VIEW

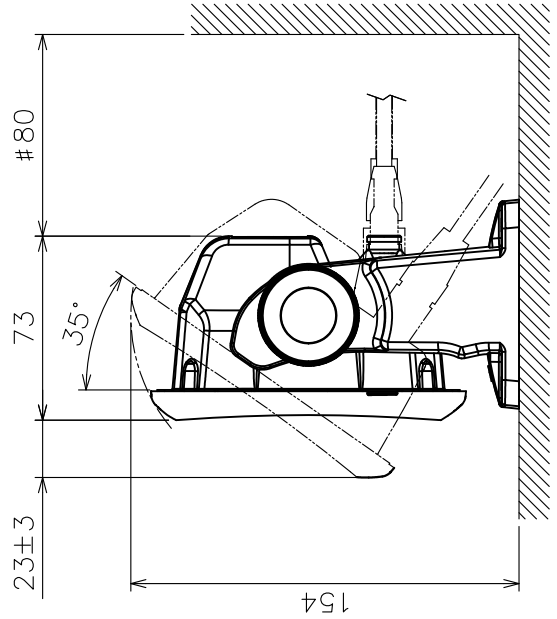
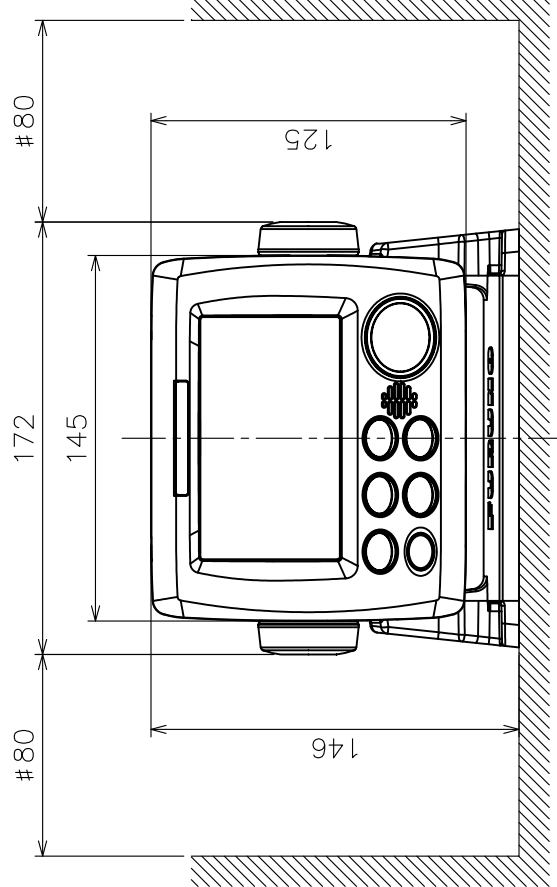

注 記

- 1) 指定外寸法公差は表 1 による。
- 2) # 印寸法は、最小サービスイ間寸法とする。
- 3) 取付用ネジはトラスタック呼び径5×20を使用のこと。

NOTE

1. TABLE 1 INDICATES TOLERANCE OF DIMENSIONS WHICH IS NOT SPECIFIED.
2. #: MINIMUM SERVICE CLEARANCE.
3. USE TAPPING SCREWS φ5x20 FOR FIXING THE UNIT.

DRAWN	2/Jul/2018	T.YAMASAKI	TITLE	RD-33	
CHECKED	2/Jul/2018	H.MAKI	名称	リモートディスプレイ (卓上装備)	
APPROVED	4/Jul/2018	H.MAKI	外寸図		
SCALE	1/MS	0.7	質量はケーブルを含みません。 MASS W/O CABLE.	NAME	REMOTE DISPLAY (TABLETOP MOUNT)
DWG.No.	C4459-001-C		26-006-100G-3	REF.No.	OUTLINE DRAWING



表 1 TABLE 1

寸法区分 (mm) DIMENSION	公差 (mm) TOLERANCE
L ≤ 50	±1.5
50 < L ≤ 100	±2.5
100 < L ≤ 500	±3



取付穴寸法図
CUTOUT DIMENSIONS

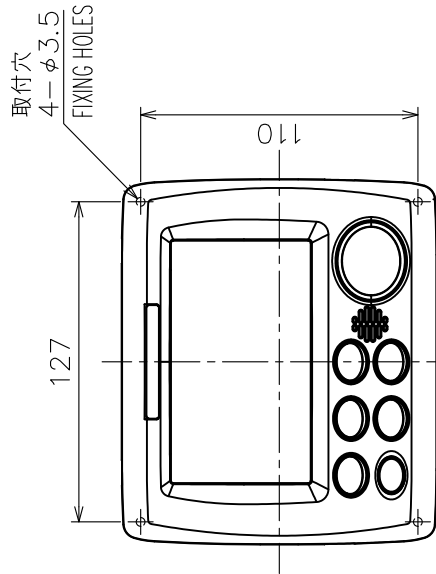
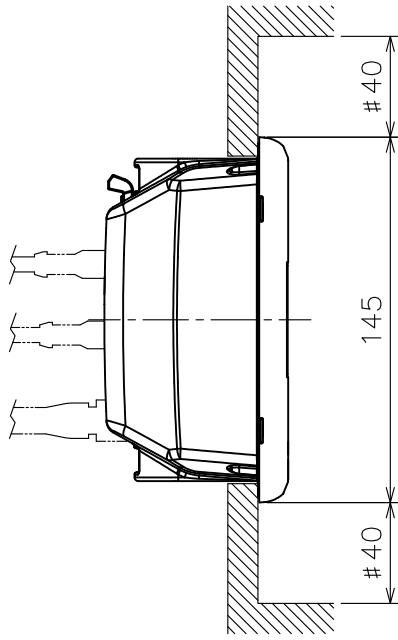
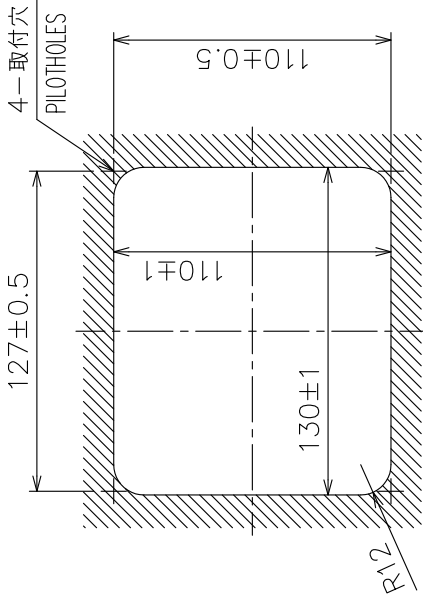
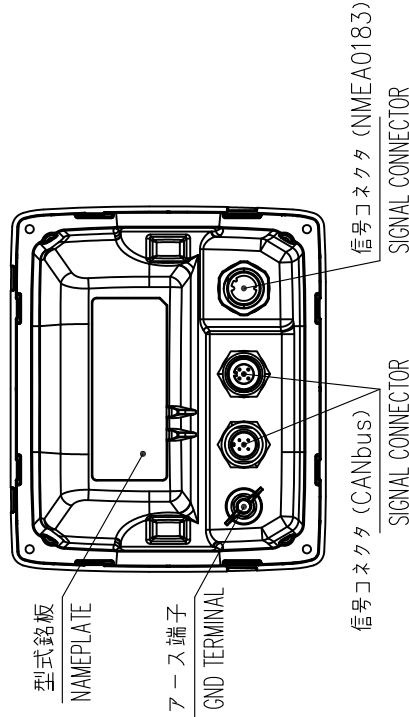
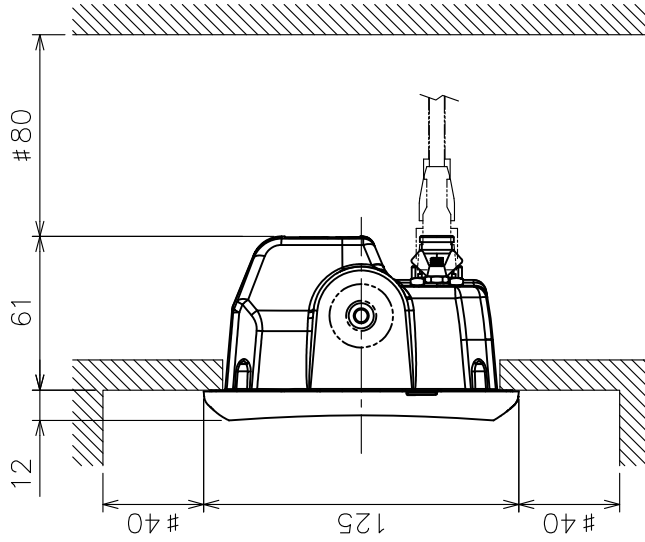

注 記

- 1) 指定外寸公差は表 1 による。
- 2) # 印寸法は、最小サービスペース寸法とする。
- 3) 取付用ネジはナベタッピンネジ呼び径3×20を使用のこと。

NOTE

1. TABLE 1 INDICATES TOLERANCE OF DIMENSIONS WHICH IS NOT SPECIFIED.
2. # MINIMUM SERVICE CLEARANCE.
3. USE TAPPING SCREWS φ3×20 FOR FIXING THE UNIT.

DRAWN	2/Jul/2018	T.YAMASAKI	TITLE	RD-33
CHECKED	2/Jul/2018	H.MAKI	名称	リモートディスプレイ (埋込装備)
APPROVED	4/Jul/2018	H.MAKI	外寸図	
SCALE	1/MASS	0.59	質量はケーブルを含みません。	
DWG.No.	C4459-G02-D		REF.No.	26-006-110G-3

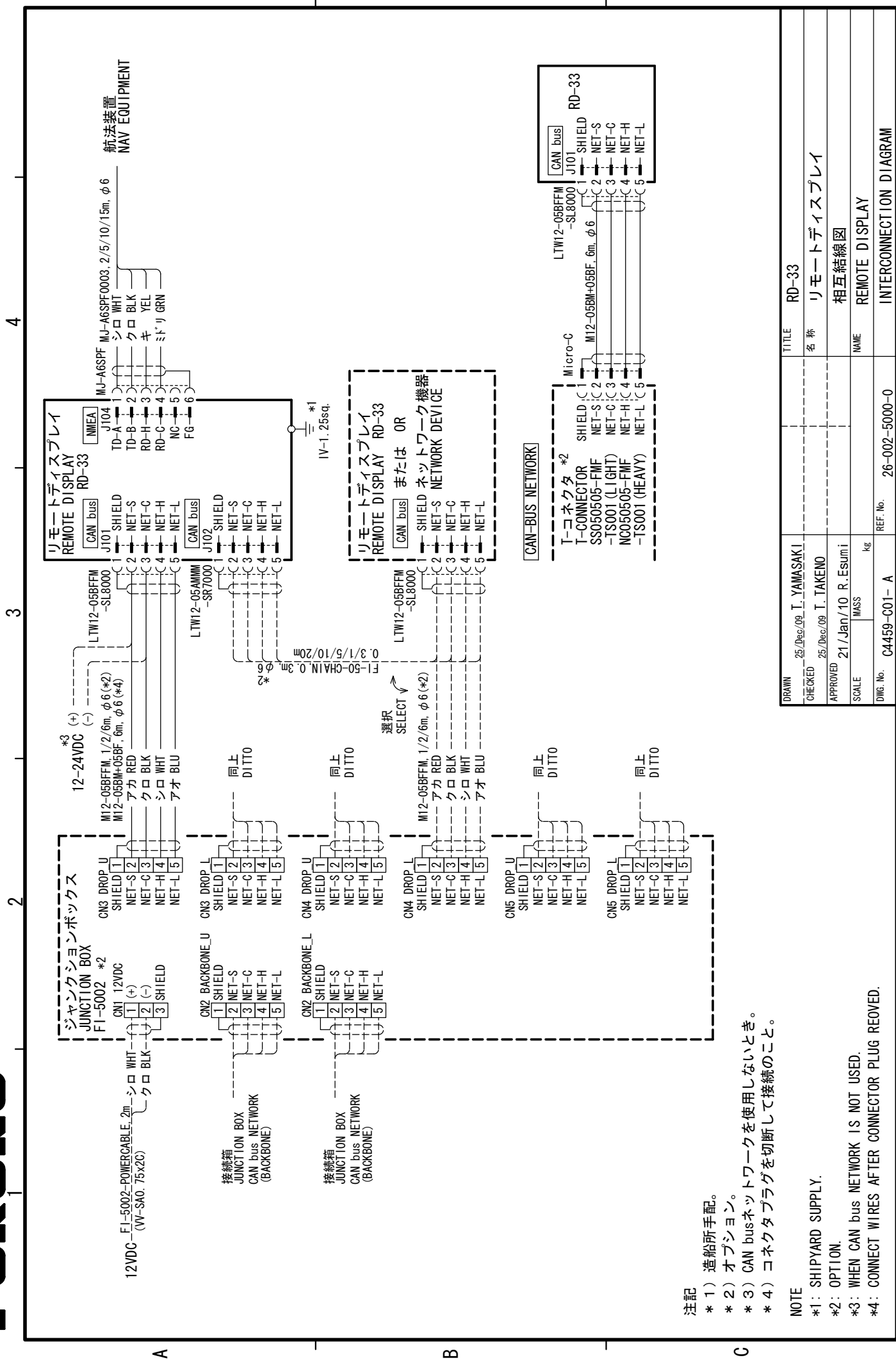

注記

- * 1) 造船所手配。
- * 2) オプション。
- * 3) CAN busネットワークを使用しないとき。
- * 4) コネクタプラグを切断して接続のこと。

NOTE

- *1: SHIPYARD SUPPLY.
- *2: OPTION.
- *3: WHEN CAN bus NETWORK IS NOT USED.
- *4: CONNECT WIRES AFTER CONNECTOR PLUG REMOVED.

DRAWN	25/Dec/09 T. YAMASAKI	TITLE	RD-33
CHECKED	25/Dec/09 T. TAKENO	名称	リモートディスプレイ
APPROVED	21/Jan/10 R. Esumi		相互結線図
SCALE	MASS	NAME	REMOTE DISPLAY
DWG. No.	C4459-C01-A	REF. No.	26-002-5000-0
			INTERCONNECTION DIAGRAM

This page is intentionally left blank .

INDEX

A

Adjustments	9-7
Alarm category	4-2
Alarm menu	4-3
Alarm status	4-1
Analog screen appearance	2-1
Anchor alarm	4-4
Arrival alarm	4-4
Audio alarm	4-1, 4-4

C

CAN bus devices	5-2
Controls	1-1
Custom screen	3-1

D

Data category	
Auto pilot	3-6
Depth	3-3
Engine	3-6
Environment	3-6
Fishery	3-6
Heading	3-4
Navigation	3-5
None	3-6
Speed	3-3
Timer	3-4
Wind	3-4
Data screen	1-4, 3-7
Data source	5-3
Daylight saving time	7-6
Demo mode	8-4
Depth alarm	4-8
Direction mode	3-10

F

Factory reset	8-4
Factory-preset screen	2-10

H

HDG/COG ref	7-7
Heading switching	3-17
Highway screen	3-15

I

Input signal	9-8
Installation	9-2

K

Key beep	7-7
Key dimmer	1-3

L

Language	7-7
Laylines	6-2
LCD test	8-2
List of terms	AP-4

Locked bearing	3-13, 7-7
Locked heading	3-13, 7-7

M

Magnetic variation	7-7
Maintenance	8-1
Menu tree	AP-1

O

Odometer alarm	4-9
Offset	7-2
Other alarms	4-10
Output signal	9-10

P

Pitch alarm	4-9
Position format	6-1
Power on/off	1-2
Programmed screen	2-2
Engine	2-9
Environment	2-8
Fishing	2-4
Navigation	2-7
Sailing	2-5
Ship	2-6

R

Received data	5-1
Response time	7-4
Roll alarm	4-9

S

Scale range	7-4
Screen brilliance	1-3
Screen division	3-1
Speed alarm	4-5
Stopwatch	3-11
System configuration	vi
System test	8-2

T

Time and date	7-5
Time difference	7-6
Timer	3-11
Trip alarm	4-9
Troubleshooting	8-2

U

Units of measurement	7-1
----------------------------	-----

V

Value reset	3-18
-------------------	------

W

Water temperature alarm	4-6
Wind angle switching	3-17
Wind mode	3-10
Wiring	9-4

INDEX

X

XTE (Cross track error)3-15
XTE alarm4-5

FURUNO Worldwide Warranty for Pleasure Boats (Except North America)

This warranty is valid for products manufactured by Furuno Electric Co. (hereafter FURUNO) and installed on a pleasure boat. Any web based purchases that are imported into other countries by anyone other than a FURUNO certified dealer may not comply with local standards. FURUNO strongly recommends against importing these products from international websites as the imported product may not work correctly and may interfere with other electronic devices. The imported product may also be in breach of the local laws and mandated technical requirements. Products imported into other countries as described previously shall not be eligible for local warranty service.

For products purchased outside of your country please contact the national distributor of Furuno products in the country where purchased.

This warranty is in addition to the customer's statutory legal rights.

1. Terms and Conditions of Warranty

FURUNO guarantees that each new FURUNO product is the result of quality materials and workmanship. The warranty is valid for a period of 2 years (24 months) from the date of the invoice, or the date of commissioning of the product by the installing certified dealer.

2. FURUNO Standard Warranty

The FURUNO standard warranty covers spare parts and labour costs associated with a warranty claim, provided that the product is returned to a FURUNO national distributor by prepaid carrier.

The FURUNO standard warranty includes:

- Repair at a FURUNO national distributor
- All spare parts for the repair
- Cost for economical shipment to customer

3. FURUNO Onboard Warranty

If the product was installed/commissioned and registered by a certified FURUNO dealer, the customer has the right to the onboard warranty.

The FURUNO onboard warranty includes

- Free shipping of the necessary parts
- Labour: Normal working hours only
- Travel time: Up to a maximum of two (2) hours
- Travel distance: Up to a maximum of one hundred and sixty (160) KM by car for the complete journey

4. Warranty Registration

For the Standard Warranty - presentation of product with serial number (8 digits serial number, 1234-5678) is sufficient. Otherwise, the invoice with serial number, name and stamp of the dealer and date of purchase is shown.

For the Onboard Warranty your FURUNO certified dealer will take care of all registrations.

5. Warranty Claims

For the Standard Warranty - simply send the defective product together with the invoice to a FURUNO national distributor. For the Onboard Warranty – contact a FURUNO national distributor or a certified dealer. Give the product's serial number and describe the problem as accurately as possible.

Warranty repairs carried out by companies/persons other than a FURUNO national distributor or a certified dealer is not covered by this warranty.

6. Warranty Limitations

When a claim is made, FURUNO has a right to choose whether to repair the product or replace it.

The FURUNO warranty is only valid if the product was correctly installed and used. Therefore, it is necessary for the customer to comply with the instructions in the handbook. Problems which result from not complying with the instruction manual are not covered by the warranty.

FURUNO is not liable for any damage caused to the vessel by using a FURUNO product.

The following are excluded from this warranty:

- a. Second-hand product
- b. Underwater unit such as transducer and hull unit
- c. Routine maintenance, alignment and calibration services.
- d. Replacement of consumable parts such as fuses, lamps, recording papers, drive belts, cables, protective covers and batteries.
- e. Magnetron and MIC with more than 1000 transmitting hours or older than 12 months, whichever comes first.
- f. Costs associated with the replacement of a transducer (e.g. Crane, docking or diver etc.).
- g. Sea trial, test and evaluation or other demonstrations.
- h. Products repaired or altered by anyone other than the FURUNO national distributor or an authorized dealer.
- i. Products on which the serial number is altered, defaced or removed.
- j. Problems resulting from an accident, negligence, misuse, improper installation, vandalism or water penetration.
- k. Damage resulting from a force majeure or other natural catastrophe or calamity.
- l. Damage from shipping or transit.
- m. Software updates, except when deemed necessary and warrantable by FURUNO.
- n. Overtime, extra labour outside of normal hours such as weekend/holiday, and travel costs above the 160 KM allowance
- o. Operator familiarization and orientation.

FURUNO Electric Company, March 1, 2011

FURUNO Warranty for North America

FURUNO U.S.A., Limited Warranty provides a twenty-four (24) months LABOR and twenty-four (24) months PARTS warranty on products from the date of installation or purchase by the original owner. Products or components that are represented as being waterproof are guaranteed to be waterproof only for, and within the limits, of the warranty period stated above. The warranty start date may not exceed eighteen (18) months from the original date of purchase by dealer from Furuno USA and applies to new equipment installed and operated in accordance with Furuno USA's published instructions.

Magnetrons and Microwave devices will be warranted for a period of 12 months from date of original equipment installation.

Furuno U.S.A., Inc. warrants each new product to be of sound material and workmanship and through its authorized dealer will exchange any parts proven to be defective in material or workmanship under normal use at no charge for a period of 24 months from the date of installation or purchase.

Furuno U.S.A., Inc., through an authorized Furuno dealer will provide labor at no cost to replace defective parts, exclusive of routine maintenance or normal adjustments, for a period of 24 months from installation date provided the work is done by Furuno U.S.A., Inc. or an AUTHORIZED Furuno dealer during normal shop hours and within a radius of 50 miles of the shop location.

A suitable proof of purchase showing date of purchase, or installation certification must be available to Furuno U.S.A., Inc., or its authorized dealer at the time of request for warranty service.

This warranty is valid for installation of products manufactured by Furuno Electric Co. (hereafter FURUNO). Any purchases from brick and mortar or web-based resellers that are imported into other countries by anyone other than a FURUNO certified dealer, agent or subsidiary may not comply with local standards. FURUNO strongly recommends against importing these products from international websites or other resellers, as the imported product may not work correctly and may interfere with other electronic devices. The imported product may also be in breach of the local laws and mandated technical requirements. Products imported into other countries, as described previously, shall not be eligible for local warranty service.

For products purchased outside of your country please contact the national distributor of Furuno products in the country where purchased.

WARRANTY REGISTRATION AND INFORMATION

To register your product for warranty, as well as see the complete warranty guidelines and limitations, please visit www.furunousa.com and click on "Support". In order to expedite repairs, warranty service on Furuno equipment is provided through its authorized dealer network. If this is not possible or practical, please contact Furuno U.S.A., Inc. to arrange warranty service.

FURUNO U.S.A., INC.
Attention: Service Coordinator
4400 N.W. Pacific Rim Boulevard
Camas, WA 98607-9408
Telephone: (360) 834-9300
FAX: (360) 834-9400

Furuno U.S.A., Inc. is proud to supply you with the highest quality in Marine Electronics. We know you had several choices when making your selection of equipment, and from everyone at Furuno we thank you. Furuno takes great pride in customer service.

EC Declaration of Conformity



We **FURUNO ELECTRIC CO., LTD.**

(Manufacturer)

9-52 Ashihara-Cho, Nishinomiya City, 662-8580, Hyogo, Japan

(Address)

declare under our sole responsibility that the product

REMOTE DISPLAY RD-33

(Model name, type number)

to which this declaration relates is in conformity with the following standard(s) or other normative document(s)

IEC 60945 Ed.4.0: 2002, clauses 9.2, 9.3, 10.3, 10.4, 10.5, 10.8 and 10.9

IEC 60945 Ed.3.0: 1996, clauses 10.2 and 10.3

(title and/or number and date of issue of the standard(s) or other normative document(s))

For assessment, see

- EMC Test Report FLI 12-09-079, December 24, 2009 prepared by Furuno Labotech International Co., Ltd.

This declaration is issued according to the Directive 2014/30/EU of the European Parliament and of the Council of 26 February 2014 on the harmonisation of the laws of the Member States relating to electromagnetic compatibility.

On behalf of Furuno Electric Co., Ltd.

Nishinomiya City, Japan
April 20, 2016

(Place and date of issue)

Yoshitaka Shogaki
Department General Manager
Quality Assurance Department

(name and signature or equivalent marking of authorized person)